

EmoTouch 3

Control Unit for Sauna Cabins



Installation Instructions for retailers

Made in Germany

CE EAC UK CA IPx4

Druck-Nr.: 2902 5150
Stand: 48/22

Documentation

Manufacturer

EOS Saunatechnik GmbH	
Schneiderstriesch 1	
35759 Driedorf, Germany	
Tel.	+49 2775 82-514
Fax	+49 2775 82-431
Email	servicecenter@eos-sauna.com
Web	www.eos-sauna.com

Original installation instructions EN







Copyright for these installation instructions remains with EOS Saunatechnik GmbH.

Copyright as per DIN ISO 16016:

The copying and distribution of this document, as well as the use and communication of its contents without express authorisation, are not permitted. Compensation will be claimed in the event of infringements.

All rights reserved with regard to patent claims or submission of design or utility patent.

Characters, symbols and illustrations

-  Additional information about an operating step
-  Cross-reference to a page
-  Read instructions
-  Result of a step
-  Table title
-  Title of figure
- \leq \geq Less than or equal to, greater than or equal to

Revision history

Date	Version	Description
1st Dec. 2022	01.31	Scope of delivery: additional sensor housing
16 March 2022	01.30	New chapter: Connecting the potential-free contact.
21 Jan. 2022	01.20	New image for sensor installation, UKCA marking added, warnings updated
15 Jan. 2021	01.10	Chapters Safety, Standards and regulations, and Potential-free contact updated
1 Aug. 2020	01.00	First version

Contents

Documentation	EN-2
1 General safety instructions	EN-5
1.1 Mounting and electrical installation	EN-5
1.2 Operator instruction	EN-6
1.3 Safety levels.....	EN-8
1.4 Standards and regulations.....	EN-8
2 Identification	EN-9
2.1 Scope of delivery	EN-9
2.2 Information about the units.....	EN-10
2.2.1 Relay box	EN-10
2.2.2 EmoTouch 3 control panel	EN-11
2.3 Technical data	EN-12
2.4 Accessories (optional).....	EN-13
2.5 Intended use	EN-14
3 Installation	EN-15
3.1 Power supply and data lines	EN-15
3.2 Installation work inside the cabin	EN-16
3.2.1 Installing the temperature sensor	EN-19
3.2.2 Installing cabin lighting	EN-21
3.2.3 Fan	EN-21
3.2.4 Potential-free contact.....	EN-22
3.3 Relay box	EN-23
3.3.1 Requirements	EN-23
3.3.2 Installing the relay box.....	EN-25
3.4 Control panel	EN-27
3.4.1 Requirements	EN-28
3.4.2 Mounting the control panel.....	EN-29
4 Electrical installation	EN-35
4.1 Circuit board assignment	EN-36
4.2 Connections	EN-37
4.2.1 Sensors.....	EN-37
4.2.2 Terminals.....	EN-39
4.3 Setting the jumper for maximum heating time.....	EN-42
4.4 Connecting data lines	EN-43
4.5 Connecting and configuring consumers.....	EN-44
4.6 Connecting the potential-free contact	EN-46
4.7 Closing the relay box housing.....	EN-46

5	Commissioning	EN-48
5.1	Operation basics	EN-48
5.1.1	User interface icons	EN-49
5.1.2	Switching on and off.....	EN-50
5.2	Setup during commissioning or after a reset	EN-50
5.3	Defining the light source manually	EN-52
5.4	Troubleshooting	EN-55
6	Installing multiple cabins	EN-56
6.1	Configuration options	EN-57
6.1.1	Configuring 1–8 sauna cabins	EN-58
6.1.2	Configuration 2 – 1 steam room and 4 additional cabins	EN-59
6.1.3	Configuring 3–2 steam rooms.....	EN-60
6.1.4	Configuration 4 – 2 steam room cabins and 4 additional cabins	EN-61
6.2	Control lines and cabin addresses	EN-62
6.3	Programming of the cabin address	EN-64
6.4	Setting up a multi-cabin installation.....	EN-65
7	General terms and conditions of service	EN-68
8	Disposal	EN-71

1

General safety instructions

1.1 Mounting and electrical installation



These installation instructions are intended for qualified personnel familiar with the laws and regulations applicable to electrical installations at the installation site. Observe the following general safety instructions during mounting, configuration and commissioning of the product.

Risk to life and limb and risk of fire

Risk to life and limb from electric shock and fire in the event of improper or faulty electrical connection. This risk remains also after completion of the installation work.

- ▶ The electrical installation of the relay box and other electrical systems or equipment with a fixed mains connection must only be performed by a trained electrician from an authorised electrical company.
- ▶ Observe the stipulations in VDE 0100 part 701.
- ▶ The system must be completely disconnected from the mains supply before commencing installation and repair work.
- ▶ The housing cover must only be removed by a specialist.

Fire hazard from overheating

Insufficient ventilation can lead to device overheating and fire. Flammable parts must not exceed a temperature of 140°C when the unit is operated as intended or in the event of a malfunction.

- ▶ Do not install control panels, relay boxes and modules in enclosed cabinets or wood panelling.
- ▶ Observe the sauna heater manufacturer's safety and installation instructions.
- ▶ Observe the cabin manufacturer's safety and installation instructions.
- ▶ Touchable glass surfaces on the outside of the cabins must not reach more than 76°C. Otherwise provide proper protection.

Damage to the unit

Corrosive or heavy saline atmospheres damage the contacts in the control panel, in the relay box and in the sensors.

- ▶ The control panel and sensors should not be installed in a corrosive or heavy saline atmosphere.

General safety instructions

Damage due to incorrect mounting location

The control unit is not suitable for outdoor use.

- ▶ It must be operated only inside buildings and may not be exposed to environmental conditions such as extreme humidity and moisture or the possible formation of condensation or corrosive substances in the ambient air, as well as other weather conditions.
- ▶ Similarly, excessive cold and extreme exposure to sunlight must be prevented.
- ▶ Protect the unit accordingly if there is an increased risk of mechanical damage.

1.2 Operator instruction

The operator of the infrared or sauna cabin must be instructed on the general safety instructions during commissioning. The operator must be given a copy of the operating instructions.

The operator must make the end user aware of safety instructions that are relevant to the end user.

Risk of electric shock

A risk to life and limb from electric shock and fire arises in the event of improper repair work. This risk remains also after work is completed.

- ▶ The housing covers must only be removed by a specialist.
- ▶ Repairs and installations must only be performed by a trained specialist.
- ▶ The system must be completely disconnected from the mains supply before commencing repair work.
- ▶ Use only original spare parts from the manufacturer.

Fire hazard



Objects placed on the sauna heaters can ignite and cause fires.

- ▶ Do not place objects on the sauna heater.
- ▶ Inspect the cabin prior to switching it on.
- ▶ If you switch on the sauna heater using a pre-set timer or a remote control, use a cover protection system or install a suitable safety system.
- ▶ When using control units with a remote control option (see EN 60335-1), protection from switching on a covered sauna heater is required.

- Risk of burns and chemical burns** Touching hot parts may lead to skin burns.
- ▶ The operator must be familiar with the unit's hot parts and be able to identify them.
 - ▶ The operator must be familiar with the settings for the heating time and understand how it is controlled.
- Health risks** Spending time in an infrared or sauna cabin can lead to serious health risks or even death for persons with health impairments.
- ▶ Persons with health impairments who spend time in a sauna must consult a doctor before entering an infrared or sauna cabin.
- Equipment damage due to overuse** The uninterrupted operation time of the sauna cabin(s) can lead to property damage.
- ▶ If the sauna cabin is used commercially, the heating time must be set so that it switches off automatically after a specific period of time.
 - ▶ If the heating does not switch off automatically after a defined heating period, cabin use must be supervised at all times.
 - ▶ Inspect the cabin before each use.
- Operation by children or persons with reduced mental capacity** Children and persons with reduced mental capacity can put themselves at risk.
- ▶ Children must be supervised to ensure they do not play with the unit.
 - ▶ Children under 8 years of age should not operate the sauna cabin.
 - ▶ The settings for the heating time must only be changed by children under 8 years of age if they are supervised by an adult.
 - ▶ The sauna cabin must only be used by persons with reduced mental capacity, or limited physical or sensory abilities under supervision or if they have been previously instructed in its use and understand the risks.
 - ▶ Children and persons who have not received proper instruction must not clean or service the system.

General safety instructions

1.3 Safety levels

Safety instructions and important operating instructions are classified according to ANSI Z535.6. Please familiarise yourself with the following terms and symbols:

WARNING

Warning

Indicates a hazardous situation which, if not avoided, could result in death or serious injury.

CAUTION

Caution

Indicates a hazardous situation which, if not avoided, could result in minor or moderate injury.

NOTICE

Notice

Indicates a hazardous situation which, if not avoided, will result in damage to the unit.

1.4 Standards and regulations

For an overview of the standards that were observed during design and construction of the sauna heaters, please refer to the individual product's technical data sheet that can be downloaded from www.eos-sauna.com. Local regulations also apply to the installation and operation of heating, sauna, and steam room systems.

2

Identification

The EmoTouch 3 control unit consists of a relay box, a control panel, a temperature sensor and the connecting cables, and is used to operate a sauna cabin.

Additional modules/devices can be connected to the relay box for total control of a sauna cabin, for example, lighting, fan and additional sensors.

2.1 Scope of delivery

The following components are included in the scope of delivery:

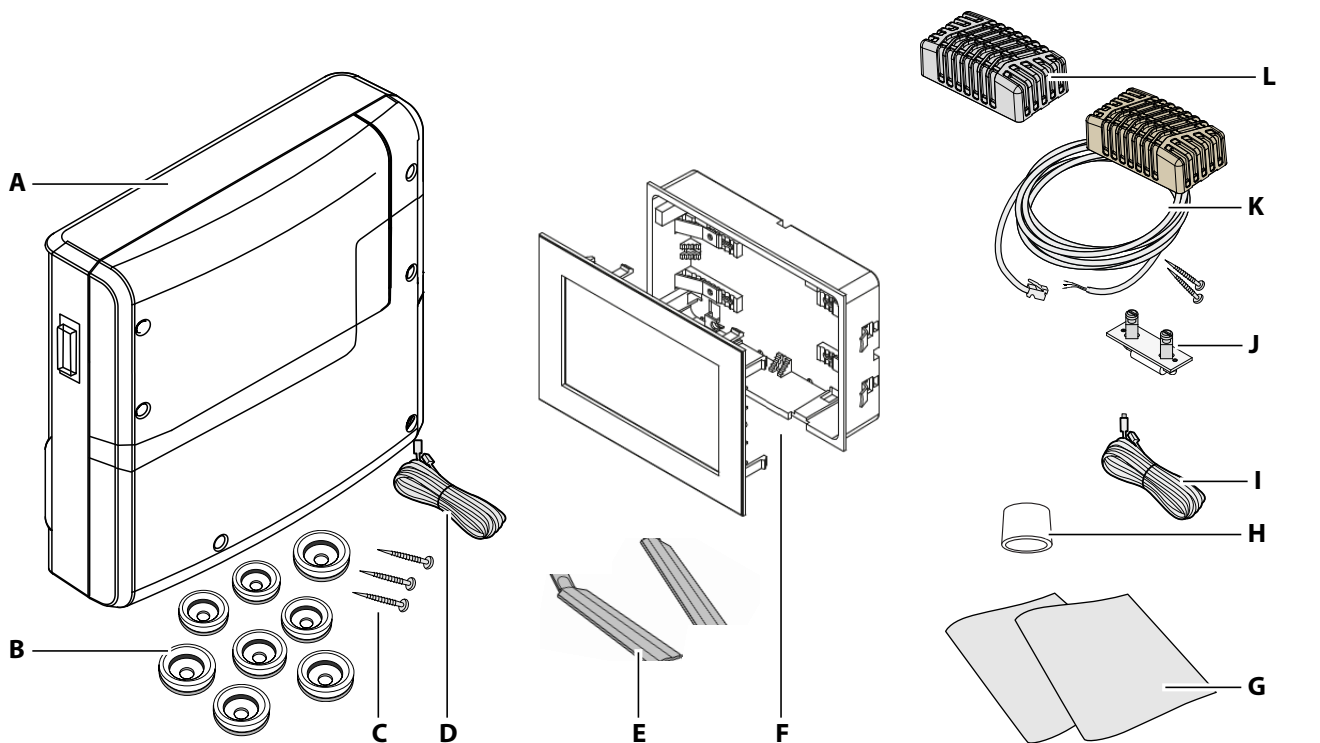

- A** Relay box with 2-piece front cover
- B** 8 bushings
- C** 3 wood screws 4 x 25 mm
- D** 5 m connecting cable with RJ14/RJ10 modular plug for control panel
- E** Removal tools for control panel
- F** EmoTouch 3 control panel with housing for mounting in the wall
- G** Installation and operating instructions
- H** Ferrite ring for data lines
- I** Line for safety temperature limiter
- J** Spare fuse for safety temperature limiter
- K** Temperature sensor including 5 m connecting cable with RJ10 plug, housing (beige), circuit board, 2 screws 4x40 mm
- L** Sensor housing (anthracite)

EmoTouch 3 scope of delivery

Ensure that you have received all parts in the scope of delivery upon receipt or before installation at the latest.

Identification

2.2 Information about the units

2.2.1 Relay box

The nameplate is attached to the underside of the base of the housing.

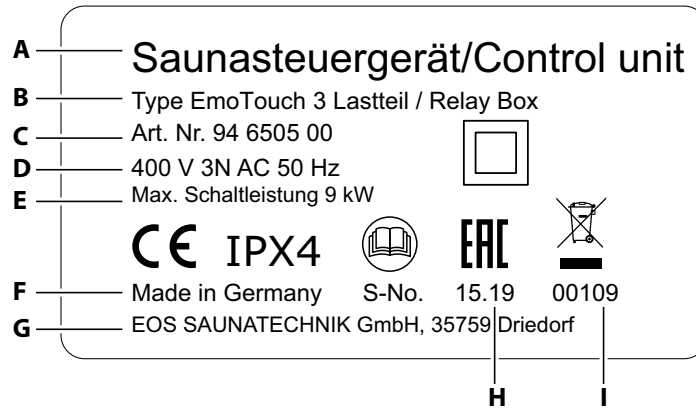

- | | |
|--|-----------------------------|
| A Name | F Country of origin |
| B Model | G Manufacturer |
| C Item number | H Manufacturing date |
| D Operating voltage | I Serial number |
| E Maximum switching output (kW) | |
|  Nameplate (example) | |

2.2.2 EmoTouch 3 control panel

The nameplate is attached to the back of the control panel.

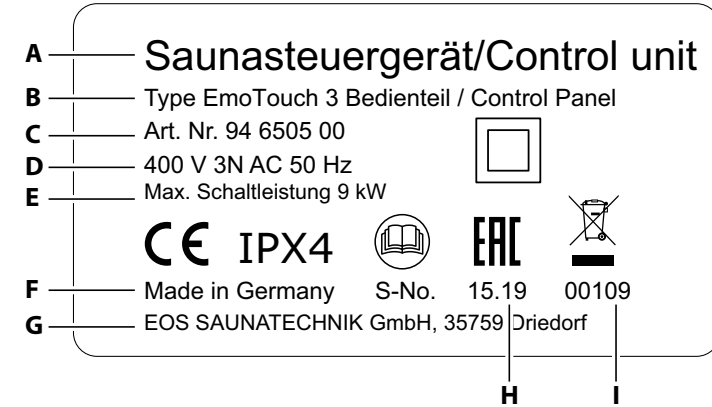

- | | |
|---|-----------------------------|
| A Name | F Country of origin |
| B Model | G Manufacturer |
| C Item number | H Manufacturing date |
| D Operating voltage | I Serial number |
| E Maximum switching output (kW) | |
|  Nameplate (example) | |

Requirements for operation and storage

The control panel must be installed outside of sauna cabins only. The mounting location must meet the following climate condition requirements:

- Ambient temperature during operation -10°C to 35°C
- Storage temperature: -20°C to 60°C

Identification

2.3 Technical data

Power supply	400 V 3 N AC 50 Hz
Switching output	Max. 9 kW resistive load, upgrade with LSG units possible
Fuse	3 x 16 A
Ambient temperature	-10°C to +35°C
S1 output	Max. 50 W/50 VA (no capacitive loads)
Supply for terminal area/sauna heater connection	0.5–2.5 mm ² rigid or flexible with wire-end ferrule, two conductors with identical cross-section per terminal can be connected.
Terminal area WM, 3, 4, light, fan	0.34–2.5 mm ² rigid or flexible with wire-end ferrule. Observe minimum cross-sections for fuse protection for the supply line.
Potential-free contact	Load rating of contact for resistive loads: - Maximum power supply: 10 A - Maximum voltage: 30 VDC/250 VAC
Storage temperature	-20°C to +60°C
Relay box housing	Plastic
Dimensions (H x W x D)	270 x 300 x 100 mm Control panel: 142 x 202 x 42 mm, mounting depth approx. 37 mm
Weight	Relay box: approx. 1.5 kg
Relay box outputs/inputs	3 x RJ10 jack for sensor connection 2 x RJ14 jack for control panel and add-on modules
Control panel outputs/inputs	4 x RJ10 jack for relay box and multi-cabin connection 1 x connection for memory card (input/host, jack type A) Connection for power adapter 24 V DC
Display	Colour capacitive 7" touchscreen display in 16:9 format Error display: Text on the display
Heating period limitation	Up to 6 hrs/12 hrs/18 hrs/infinite
Temperature control	30°C–115°C (dry sauna mode) 30°C–70°C (humidity mode)
Humidity regulation	Time-proportionally or optionally according to % rel. air humidity with connected humidity sensor
Sensor system	Digital sensor with safety temperature limiter 139°C
Control characteristics	Digital two-point control
Connection for fan*	Min. 5 W, max. 150 W (only fan without starting capacitor) Use only fans that are suitable for phase control, otherwise the fan or the control unit can be damaged.
Connection for lighting*	Min. 5 W (20 mA), resistive load, max. 100 W Dimmable energy-saving bulbs, max. 35 W Light source with conventional transformers, max. 60 VA. Use only dimmable light sources.

* Fan and light connections are protected by a joint 2AF fuse.

2.4 Accessories (optional)

Accessories	Item no.
20 m connecting cable for temperature sensor	94.6281
50 m connecting cable for temperature sensor	94.6282
10 m connecting cable for control panel (RJ10/RJ14)	94.6802
25 m connecting cable for control panel (RJ10/RJ14)	94.6285
50 m connecting cable for control panel (RJ10/RJ14)	94.6968
100 m connecting cable for control panel (RJ10/RJ14)	94.6969
10 m connecting cable for sauna bus (RJ12/RJ12)	94.5861
25 m connecting cable for sauna bus (RJ12/RJ12)	94.4647
50 m connecting cable for sauna bus (RJ12/RJ12)	94.4648
Mains adapter 230 V for control panel with cable length > 25 m	94.6671
Bench sensor	94.5725
Humidity sensor	94.5726
SBM-HOT	94.6800
SBM-ECO	94.6980
IR module as installation add-on	94.6966
IR plug-in module with adapter cable	94.2046
IR plug-in module without adapter cable	94.4960
2.5 m connecting cable for IR plug-in module	94.4396
Set SBM ECO push button	94.6980
SBM-WCI-01 web app module	94.5987
SBM remote start	94.5782
SBM-FL75/150 coloured light module	94.5996, 94.6007
SBM-S BT sound module	94.5920, 94.5921
Infrared receiver for coloured light module and sound module	94.6810
SBM-GLT-MOD HOME Modbus module	94.7077
SBM-GLT-KNX HOME KNX module	94.7078
Modular distributor RJ12 for connecting cable for control panel and sauna bus	2001.5298

2.5 Intended use

In conjunction with a suitable sauna heater, the EmoTouch 3 control unit is intended to be used only to heat sauna cabins. It is suitable for residential and commercial sauna cabins.

The relay box and control panel are intended only for mounting on the wall.

The control unit is not suitable for outdoor use.





It must be operated only inside buildings and may not be exposed to environmental conditions such as extreme humidity and moisture or the possible formation of condensation or corrosive substances in the ambient air, as well as other weather conditions. Similarly, excessive cold and extreme exposure to sunlight must be prevented. Protect the unit accordingly if there is an increased risk of mechanical damage.

Foreseeable misuse

The following are considered instances of foreseeable misuse:

- The control and sensor cable plugs are plugged in incorrectly.
- The unit is operated without knowledge of or compliance with the safety instructions.
- Operating, service and maintenance requirements are not observed.
- The unit is operated after technical or other modifications are made to the relay box.
- The unit is operated by children or persons with reduced mental capacity or by persons who have not been thoroughly instructed in its use.

The manufacturer is not liable for unauthorised modifications made to the equipment and damages resulting from these modifications. The person modifying the equipment alone shall bear the associated risk.

 General safety instructions,  EN-5

3

Installation

This chapter describes how to install the relay box, the control panel and the most important components.

Heat-resistant cables must be used to connect the sauna heater, vapouriser(s), lighting, fan(s) or other components if they are installed inside the sauna cabin or in the cabin wall.

NOTICE

Damage due to incorrect mounting location

The control unit is not suitable for outdoor use.

- ▶ It must be operated only inside buildings and may not be exposed to environmental conditions such as extreme humidity and moisture or the possible formation of condensation or corrosive substances in the ambient air, as well as other weather conditions.
- ▶ Similarly, excessive cold and extreme exposure to sunlight must be prevented.
- ▶ Protect the unit accordingly if there is an increased risk of mechanical damage.

3.1 Power supply and data lines

All electrical installations and all connecting lines that are installed inside a cabin must be suitable for an ambient temperature of at least 170°C and protection class IPx4 or be suitable for use in a steam room (IP 65).

All lines must be routed in such a way that they are well-protected, e.g. in a cable duct.

NOTICE

Electronics malfunctions

Routing data and power supply lines together can lead to electronics malfunctions because, e.g. because the sensor will not be detected.

- ▶ Do not route sensor and sauna bus lines together with power supply lines.
- ▶ Route separate cable ducts.

Line routing

The control line should be routed between the insulation and the outer wall of the cabin. If it is installed on the cabin wall, it should be routed through a cable duct. Cabin insulation must be installed in such a way that the temperature in the area in which cables are routed cannot exceed 75°C.

Extending the control panel's control line

For longer connections, special RJ10/RJ14 connecting cables with lengths of 10 m, 25 m, and 50 m are available as an option. A power adapter is required for cables 25 m or longer.

Alternately, the supplied (as standard) 5 m line can also be extended with an RJ12/RJ12 coupling and an RJ12/RJ12 extension cord.

The extensions and couplings are available as options.

See 2.4 Accessories (optional), [EN-13](#)

3.2 Installation work inside the cabin

At minimum, the cabin lighting and a temperature sensor (main sensor) must be installed inside the cabin. Additional connections are possible, depending on the amenities, e.g. coloured lights and audio systems as optional add-on modules.

All electrical installations and all connecting lines that are installed inside a sauna cabin must be suitable for an ambient temperature of at least 170°C and protection class IPx4 or be suitable for use in a steam room (IP 65).

NOTICE

Equipment damage due to improper installation

Additional modules can be mounted in a cabin.

- ▶ Connect the safety temperature limiter only to the relay box.
 - ▶ Always connect the safety temperature limiter as an isolated contact.
 - ▶ If the installation uses multiple sauna heaters, multiple safety temperature limiters may be required. Observe the separate EOS instructions.
-

Temperature sensor requirements

⚠ CAUTION

Fire hazard from overheating

Requirements that apply to installing the main sensor may exist for certain sauna heaters.

- ▶ Before installation, ensure that there are no heater-specific requirements that apply to installing the sensor.

The main sensor (heater sensor) must be installed where expected temperatures are the highest, meaning above the sauna heater. Proper installation is necessary to ensure compliance with the temperature limits and to ensure that there is only a very slight fluctuation in temperature in the areas of the sauna cabin where there are reclining options.

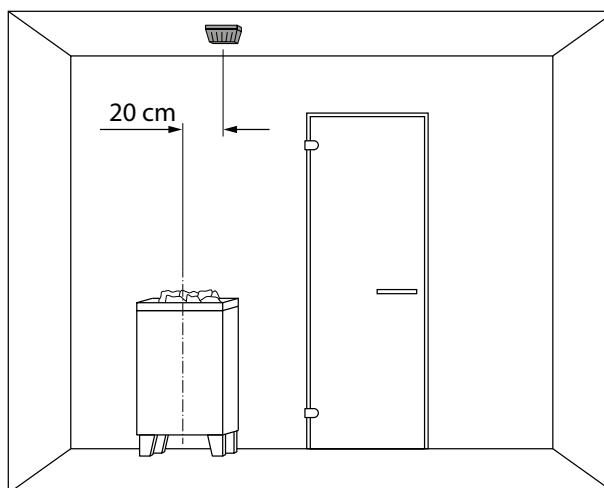

 Installation configuration above the heater

The main sensor is installed in observance of the following distances from the cabin wall, depending on the cabin size.

Installation

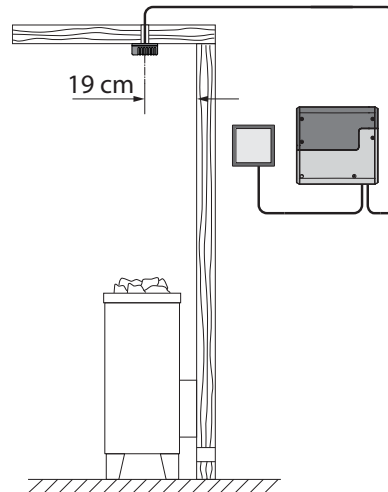

Cabin smaller than 2 x 2 m

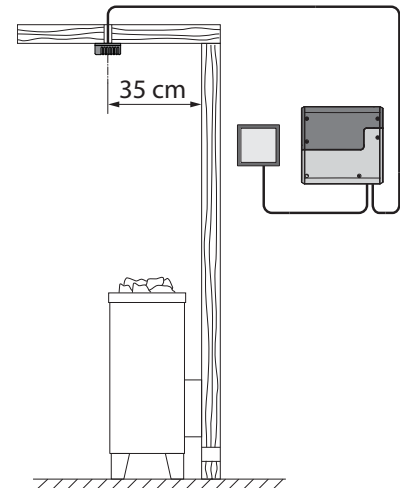

Cabin larger than 2 x 2 m

☒ Installation configuration – main sensor (heater sensor) distance from wall

Bench sensor requirements

The bench sensor is mounted on the ceiling above the back sauna bench across from the sauna heater.

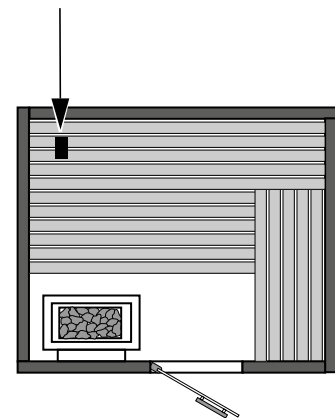
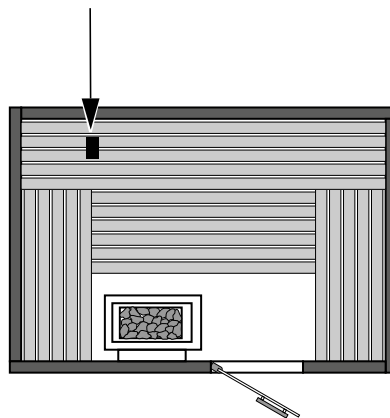

☒ Installation configuration – bench sensor

Humidity sensor requirements

The humidity sensor (optional) is installed in the middle of the side wall facing away from the sauna heater and door, at a height of approx. 150 cm.

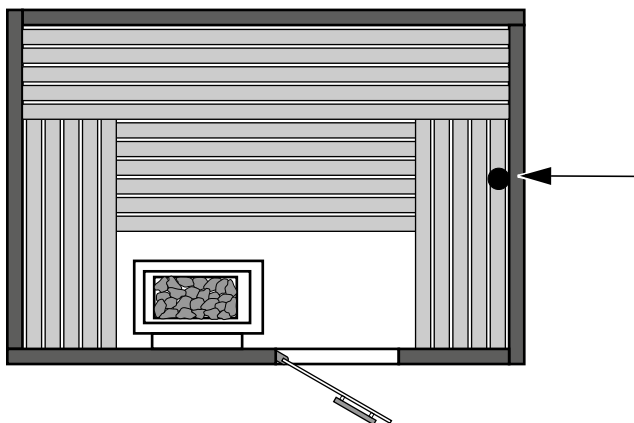

☒ Installation configuration – humidity sensor

3.2.1 Installing the temperature sensor

The main sensor must be installed where expected temperatures are the highest.

Hardware + tools:

- Temperature sensor and connecting cables
- Drill used to drill a hole in the cabin ceiling
- Screwdriver
- Taut wire, as needed

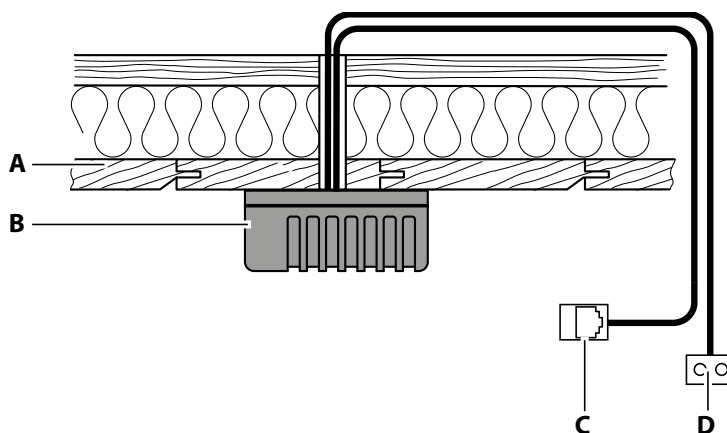

- | | |
|-------------------------------------|---|
| A Cabin ceiling | C RJ10 plug for relay box |
| B Temperature sensor housing | D Line for safety temperature limiter (2-pole) |

☒ Installation diagram

Installation

► Installing the temperature sensor in the cabin

- 1 Determine a suitable location for the installation.
 - ⓘ The main sensor (heater sensor) must be installed on the cabin ceiling above the sauna heater. A second sensor (bench sensor) can be installed above the back bench.
- 2 Drill a hole in the cabin ceiling for the cable.
- 3 **NOTICE** Do not pull at the plug when routing the control line(s). Doing so could damage the line. Attach the taut wire only to the cable. Route the sensor cable through the hole.
- 4 Open the temperature sensor's housing and connect the sensor bus cable.

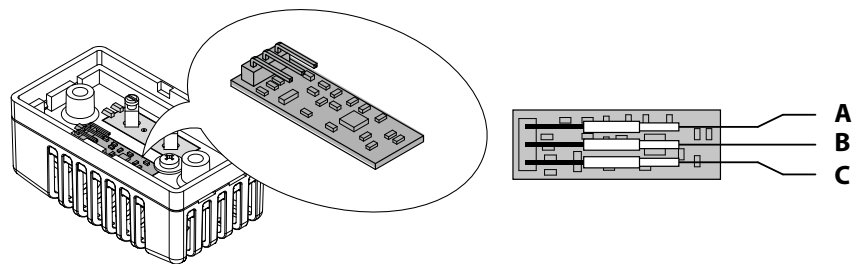

- A** White (sensor bus)
- B** Green (sensor bus)
- C** Brown (sensor bus)

- 5 Connect the lines for the safety temperature limiter.

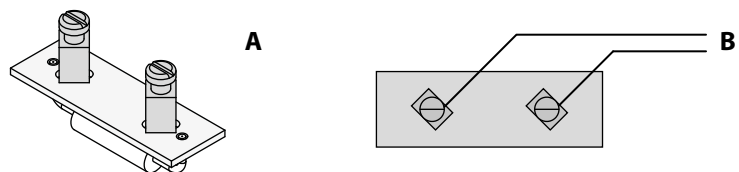

A Safety temperature limiter

B Lines for safety temperature limiter (white)

- ⓘ The safety temperature limiter is available only in the main sensor. This step is not necessary for the bench sensor because it does not have a safety temperature limiter.
- ⓘ If multiple sauna heaters are installed in a sauna cabin, it may be necessary to install additional safety temperature limiters and connect them in series.

- 6 Screw the sensor plate to the cabin ceiling and close the housing.

📖 See 📄 Schematic view of connections, 📄 EN-36.

3.2.2 Installing cabin lighting

Lighting can be installed anywhere, however not near rising hot air. The light output in the relay box is set to inductive load by default, but light bulbs, halogen HV bulbs and other resistive loads may also be connected to it. If required, the light output can also be manually set to capacitive loads.

Setting the light output, see 5.3 Defining the light source manually,  EN-52.

Cabin lighting is not included in the scope of delivery. Observe the separate installation instructions for lighting.

Light source requirements:



- Lighting must be dimmable
- Minimal output 5 W
- Resistive loads max. 100 W
- Dimmable energy-saving bulbs max. 35 W
- Light sources with conventional transformers max. 60 VA
- Dimmable LED bulbs max. 60 W

NOTICE

Material damage

Lighting and the control panel could become damaged if non-dimmable light sources are installed. In this case, the warranty becomes void.

- ▶ Do not install the lighting in areas with rising hot air.
- ▶ The lighting must conform to protection class IPX4 (splash-proof) and be resistant to ambient temperatures.
- ▶ Connect only dimmable light sources.

 Control line connection: 4.2 Connections,  EN-37

3.2.3 Fan

An exhaust fan can be mounted in the cabin and set via the control panel. It must be possible to control the fan's speed using phase control.

The fan can be installed anywhere, however never near hot air that rises from the heater.

The fan is not included in the scope of delivery. Observe the separate installation instructions for the fan.

Fan requirements

- Minimal output 5 W
- Maximum output 150 W
- Voltage 230 V 1N AC
- Suitable for use in sauna cabins

Control line connection: 4.2 Connections,  EN-37

3.2.4 Potential-free contact

A potential-free contact (PFC) is available on the relay box's circuit board. You can include this NO contact in any electric circuit to switch an external load or transmit a signal.



NOTICE**Property damage due to short circuiting**

The supply line can short circuit if you use the mains connections L1, L2 or L3 to supply the electric circuit connected to the potential-free contact.

- ▶ Use the EmoTouch 3 mains connections only for the sauna heater.
- ▶ Do not connect additional devices to the EmoTouch 3 mains connections.
- ▶ Connect the device connected to the potential-free contact and ensure that it is protected from short circuiting.
- ▶ Observe the maximum load of the potential-free contact.

Maximum load

Resistive load/alternating current	Max. 250 V AC/10 A
Inductive load/alternating current	500 VA
Direct current	Up to 30 V DC max. 10 A (300 W)
	Up to 110 V DC max. 0.3 A (33 W)
	Up to 220 V DC max. 0.12 A (26.4 W)

 PFC connection: 4.6 Connecting the potential-free contact,  EN-46

3.3 Relay box

The relay box must only be mounted outside of the cabin. Observe the following guidelines.

3.3.1 Requirements

⚠ WARNING

Risk to life and limb and risk of fire

Risk to life and limb from electric shock and fire in the event of improper or faulty electrical connection. This risk remains also after completion of the installation work.

- ▶ Do not install relay boxes in enclosed cabinets or wood paneling.

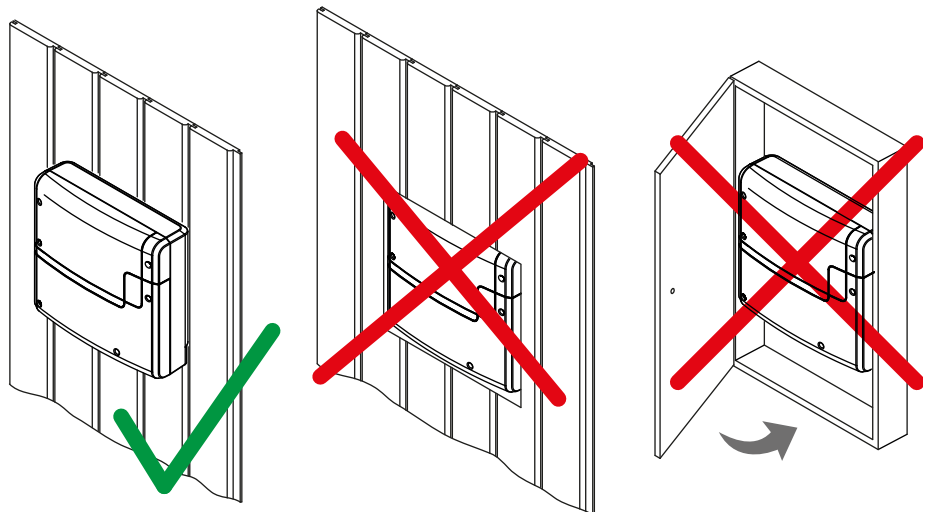

☒ Proper and improper relay box installation

Recommended installation locations are:

- Outer wall of the cabin, however not outside of the building.
- Plant room

If empty conduits for electrical installations are already present, this dictates the position of the relay box.

All lines should be routed before installing the relay box. Connections can be established later. Data lines must be routed and connected in such a way that they are not openly accessible.

NOTICE**Electronics malfunctions**

Routing data and power supply lines together can lead to electronics malfunctions because, e.g. because the sensor will not be detected.

- ▶ Do not route sensor and sauna bus lines together with power supply lines.
- ▶ Route cable ducts separately.

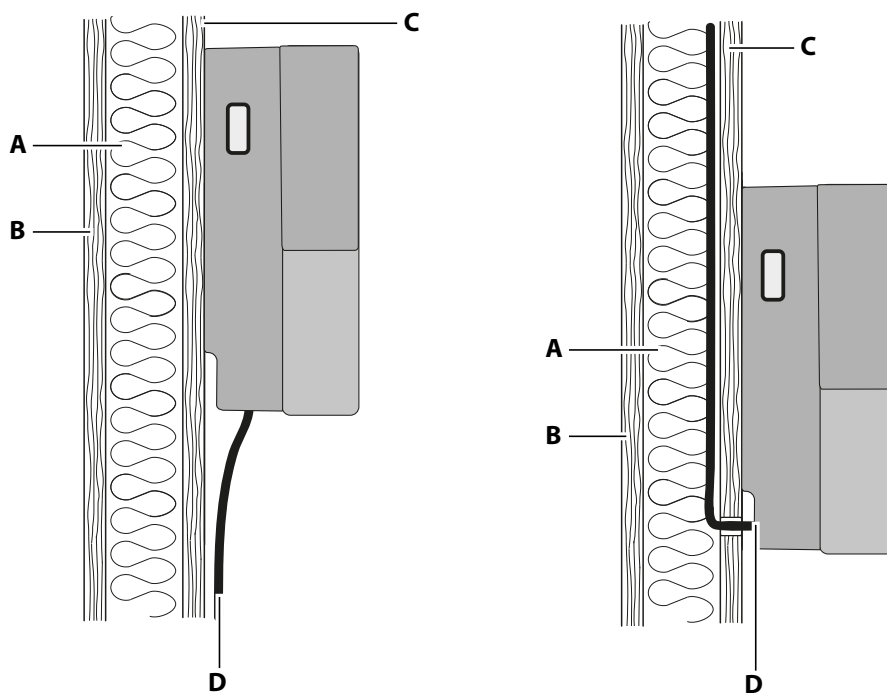
Line routing

- | | |
|----------------------------------|----------------------------------|
| A Insulation | C Outer wall of the cabin |
| B Inner wall of the cabin | D Connecting lines |

☒ Diagram – routing of data and control line(s)

The power supply, S-Bus and sensor lines can be routed to the relay box as follows:

- The lines can be routed along the outer wall of the cabin. They are then passed into the housing from below. If they are not routed through a cable conduit or a duct, they must be secured so they cannot be pulled out.
- The cables can be routed between the insulation and the outer wall of the cabin. They are then passed into the housing from the rear.

In both cases, the cabin insulation must be installed in such a way that the temperature in the area in which cables are routed cannot exceed 75°C.

3.3.2 Installing the relay box

Necessary steps:

- ▶ Preparing for installation, [EN-25](#)
- ▶ Removing the housing cover, [EN-25](#)
- ▶ Installing the relay box, [EN-26](#)

Tools + hardware

- Drill
- Wood screws 4 x 25 mm
- Mounting on a fixed wall: Screws 4 x 25 mm and corresponding anchors

▶ Preparing for installation

- 1 Determine a suitable location for the installation.
- 2 Route the lines.

▶ Removing the housing cover

- 1 Unscrew the 6 screws for both parts of the housing.

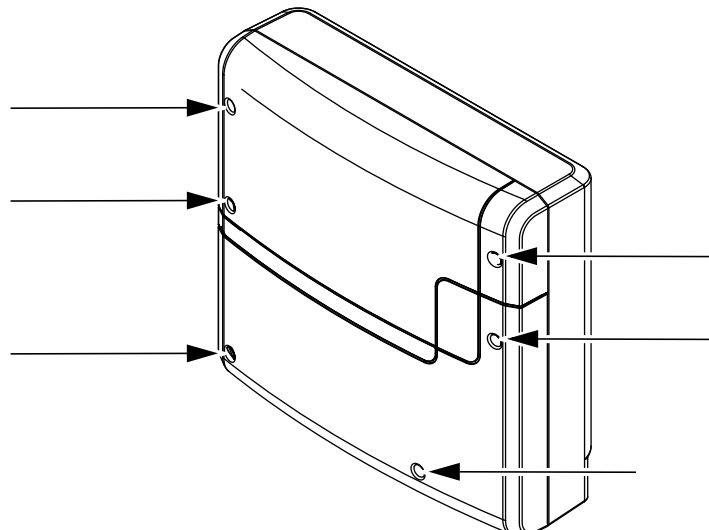

- 2 Remove both halves of the cover.

Installation

► Installing the relay box

- 1 Drill one (1) hole above and two (2) holes below.

Horizontal distance between drill holes: 210 mm

Vertical distance between drill holes: 180 mm

- 2 Insert the anchors as needed and screw in the top screw.

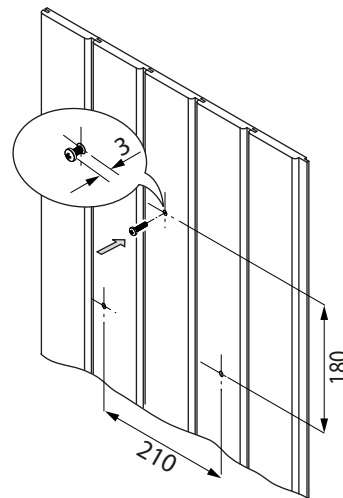

- ⓘ Allow the screw to protrude approx. 3 mm so you can hook in the relay box.

- 3 Open the relay box conduits for the lines.

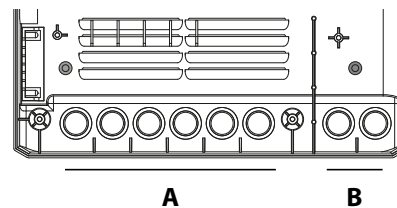

- A** Lines with mains voltage, e.g. mains supply line, heat **B** Lines with low voltage, e.g. sensor line, S-Bus (sauna bus)

- ⓘ Either from below or from the rear.

- 4 Insert supplied rubber grommets into the openings of the lower part of the housing.
- 5 Route the connecting cables through the openings.

- 6 Hook the relay box into the upper screw using the upper mounting hole.

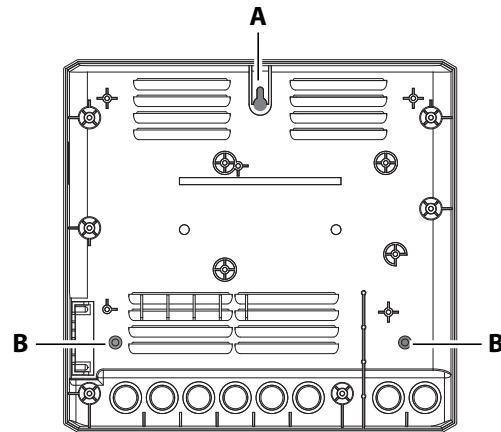

A Top mounting hole

B Lower mounting holes

- 7 Securely tighten the relay box using the two lower mounting holes.
- ① Once you have completed all installation work, you can connect the consumers and plug in the lines.
 - ① 4.4 Connecting data lines, [EN-43](#)
 - 4.3 Setting the jumper for maximum heating time, [EN-42](#)
 - 4.5 Connecting and configuring consumers, [EN-44](#)

3.4 Control panel

The EmoTouch 3 control panel is designed for mounting in the wall. If empty conduits for electrical installations are already present, this dictates the position of the control panel.

- The control panel must only be mounted outside of the cabin. The outside wall of the cabin is the preferred mounting location.
- Installation depth in the wall min. 35 mm
- With a line length over 25 m: Bus amplifier with power adapter (230 V mains connection) required. A socket near the installation location of the control panel is required for this (max. 1.5 m away).
- Max. line length: 50 m.

NOTICE

Damage due to steam and humidity

Steam can escape when the door is opened, which can fog over the control panel. This can lead to the formation of condensation in the control panel and system downtime.

- ▶ Mount the control panel far enough away from the area where steam is emitted and can spread.
- ▶ Mount the control panel on the hinge side of the door.

3.4.1 Requirements

Wall mounting

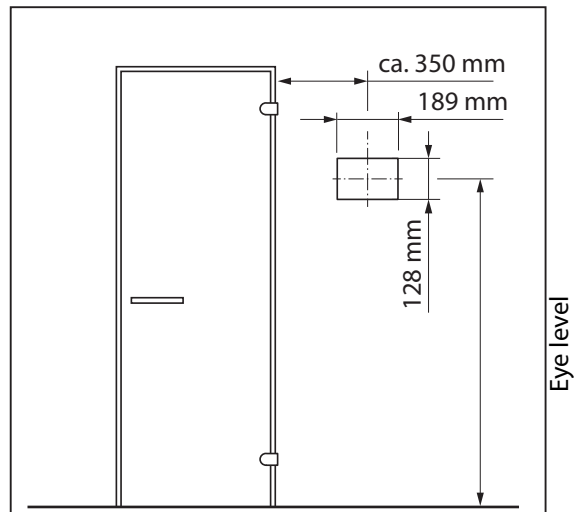

☒ Installation dimensions for the control panel

The following distances must be observed:

Distance from the cabin door	Min. 350 mm on the hinge side
Height of the middle of the display	Eye level
Mounting height	128 mm
Mounting width	189 mm
Mounting depth	Min. 37 mm

Line routing

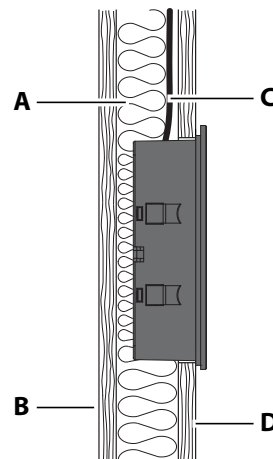

- A** Insulation
 - B** Inner wall of the cabin
 - C** Control line
 - D** Outer wall of the cabin
- ☒ Guide for data and control line(s)

The control line should be routed between the insulation and the outer wall of the cabin. Cabin insulation must be installed in such a way that the temperature of the external wall cannot exceed 35°C. If the line is installed on the cabin's exterior wall, it should be protected by a cable duct.

Extending the control panel's control line

The control line may be extended to approx. 50 m, if necessary.

If the line length is greater than 25 m, a special bus amplifier (accessory) with power supply must also be installed near the control panel and connected to it. The bus amplifier requires a 230 V mains connection at a distance of max. 1.5 m from the installation location.

The extension is attached to the side of the relay box. This requires a coupling (RJ12/RJ12) and an extension cord with an RJ12 plug (optional accessory).

3.4.2 Mounting the control panel

The control lines are connected to the control panel. Depending on the system installation, they lead to the cabin, to the relay box, and to the control panel. These control lines are fed through the bottom of the housing. Therefore, they must be installed once the cut in the wall has been made.

Necessary steps:

- ▶ Create wall cut-out and lay the control line, [EN-30](#)
- ▶ Mounting the housing, [EN-31](#)
- ▶ Plugging in the lines, [EN-32](#)
- ▶ Plugging in the control panel, [EN-33](#)

Tools required:

- Saw for wall cut-out
- Phillips screwdriver
- Removal tool to loosen the display (included in the scope of delivery)
- Taut wire, as needed

Installation

► Create wall cut-out and lay the control line

- 1 Determine a suitable location for the installation.
- 2 Prepare a wall cut-out:

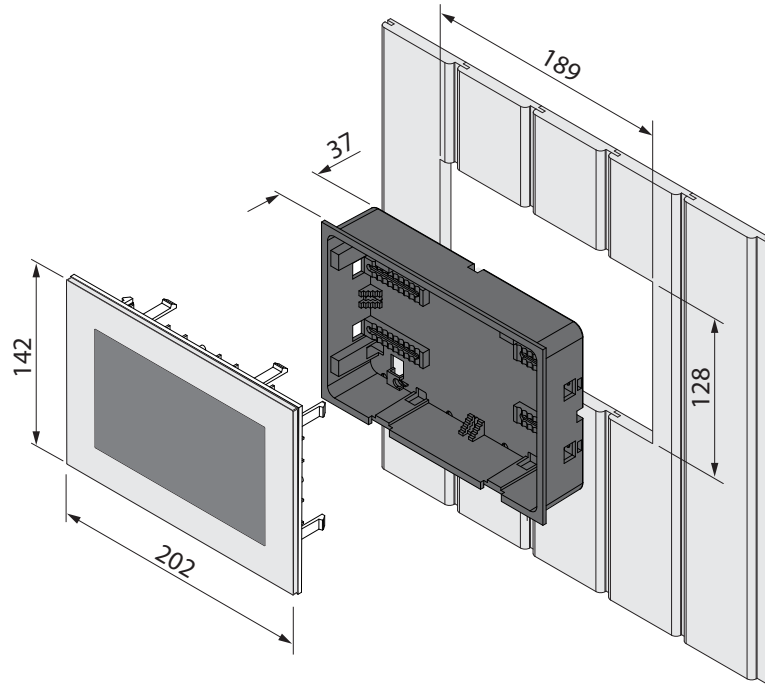

Mounting depth: min. 37 mm

Height x width = 128 x 189 mm

The mid-point of the control panel should be at eye level.

- 3 **NOTICE** Do not pull at the plug when routing the control line(s). Doing so could damage the line. Attach the taut wire only to the cable. Route the control lines from the relay box to the control panel.
① The smaller RJ10 plug on the connecting cable must be routed to the control panel.

► Mounting the housing

1 NOTICE The control panel's housing and display are not mounted upon delivery. Do not drop the control panel. The display's glass plate cannot be replaced. Remove the protective film from the panel after mounting is completed.

Insert the two removal tools in the slots on the lower edge of the control panel and carefully remove the display.

2 Loosen the clip screws in the housing and slide the clips inward.

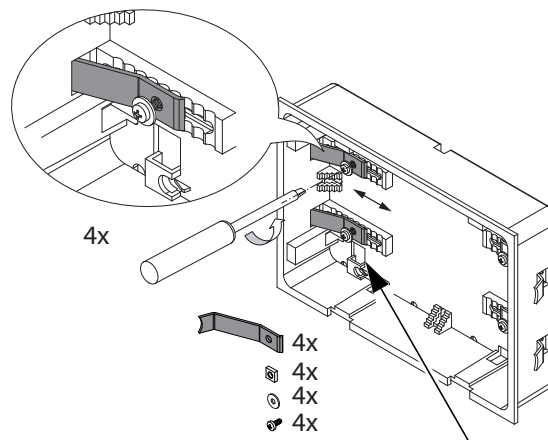

3 After routing, pull the control lines through the opening in the housing.

① Do not pull the control line too taut so that you can easily remove the control panel at a later time.

4 Place the bottom piece in the prepared wall cut-out.

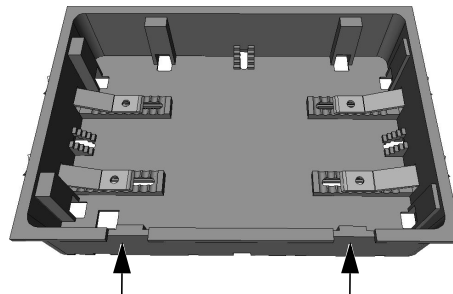

① Observe the sticker on the housing (oben/up).

① When fixing the unit to the wall, ensure that the bottom of the unit is aligned properly. The side with the hole for the connecting cables and the slots for the removal tool must be facing downwards.

Installation

- 5 Slide the clips as far out as they will go and tighten the screws clockwise.

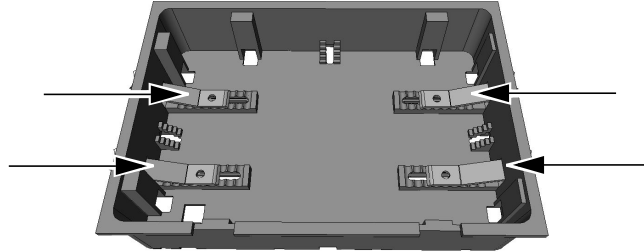

ⓘ The housing must sit firmly in the wall cut-out.

- 6 As an alternative to clips, the housing can also be fixed by using screws. Screw the screws into the holes on the 4 sides to fix the housing.

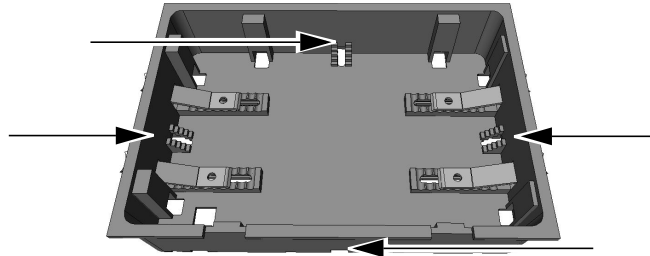

► Plugging in the lines

- 1 Pull the control lines from the relay box through the ferrite ring twice.

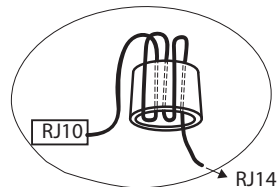

- 2 Slide the ferrite ring onto the bridge on the mounting plate.

3 Connect the control line to socket 1/2 using the RJ10 plug.

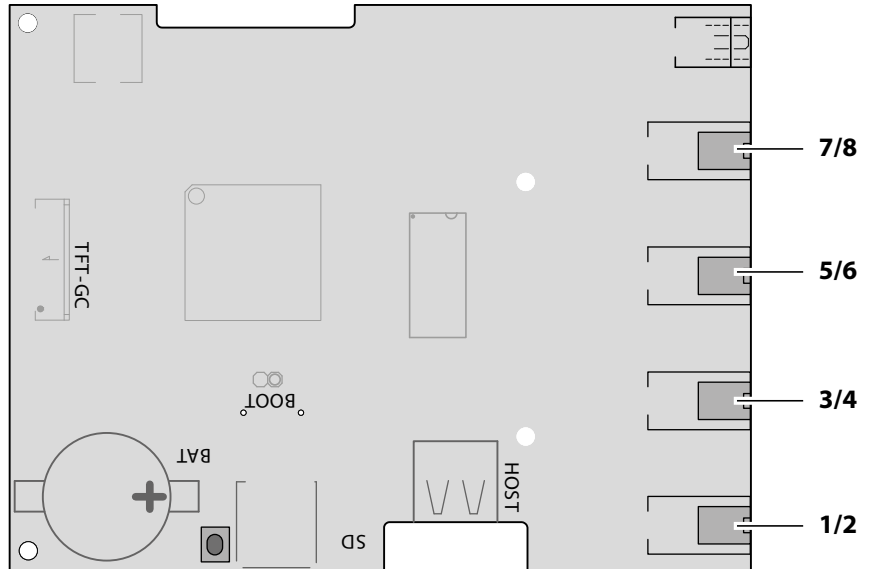

EmoTouch 3 circuit board – jacks

① Plug for multi-cabin connection, see 6.1 Configuration options, EN-57

► **Plugging in the control panel**

- 1** Place the control panel directly in front of the bottom piece.
 - ① Ensure that it is aligned properly. Socket 1/2 must face downward.

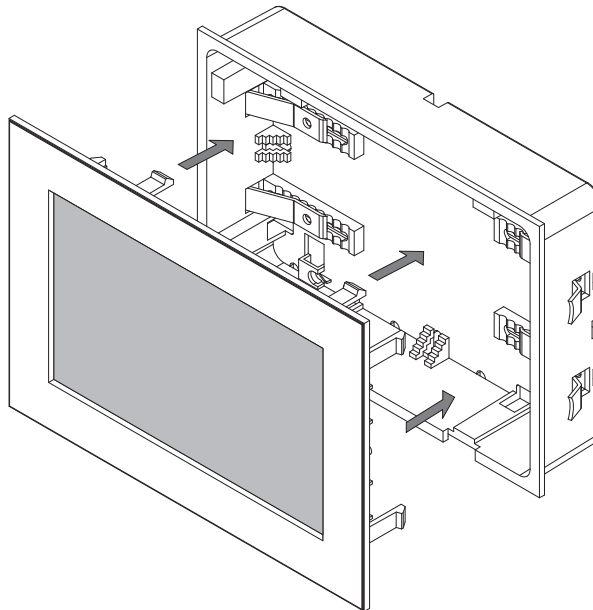

Installation

- 2** Press the control panel carefully into the housing with a consistent amount of pressure until it audibly snaps into place.
 - ① To remove it, insert the two removal tools in the slots on the lower edge of the control panel and carefully remove the display.
- 3** Remove the foil from the control panel.
 - ① For commissioning information, see 5.2 Setup during commissioning or after a reset, [EN-50](#)

4

Electrical installation

This chapter describes how to connect the relay box's circuit board lines. For information on setup of the control panel, see chapter Commissioning, [EN-48](#).

You can connect both sauna heaters for Finnish mode and as Bi-O heaters. Both types are referred to as sauna heaters in the following section. However, in instances where different settings must be made, they will be referred to specifically by name.

Recommended installation sequence

Before commencing installation, ensure that the relay box, the control panel, and the main sensor are mounted. Furthermore, all cabin work must be complete: sauna heater, light, humidity sensor if required, etc.

Complete installation in the following sequence:

- Plug the S-Bus and sensor lines into the relay box.
- Connect the consumer lines (sauna heater, light, fan, etc.) to the relay box.
- Establish connection to the power supply.
- Switch on the relay box and control panel.
- In a multi-cabin installation: Program the cabin address.
- Configure additional settings at the control panel, e.g. target temperature.

Electrical installation

4.1 Circuit board assignment

The sauna heater, cabin lighting, fan and module are connected via the relay box. All connected modules are controlled by the control panel.

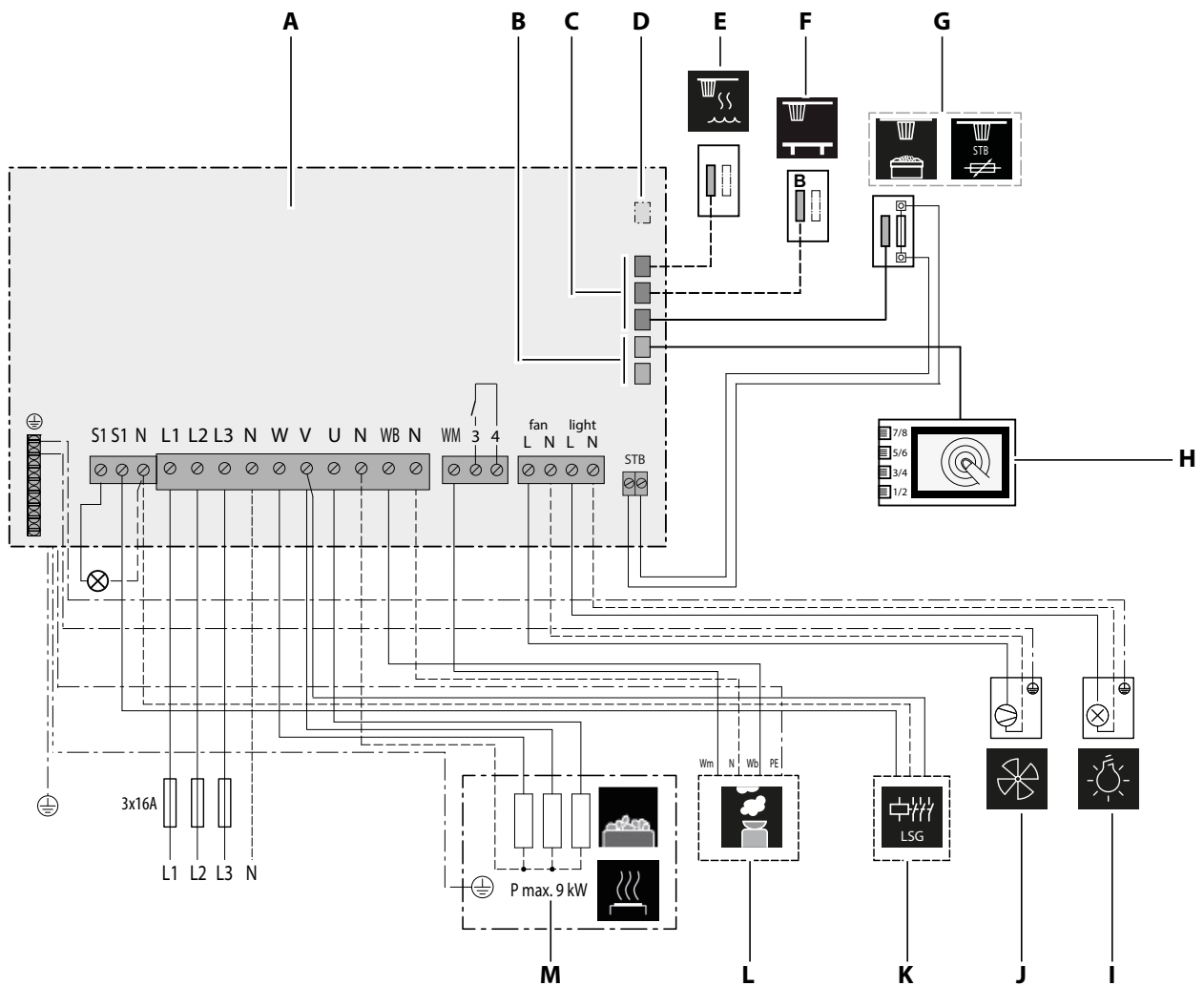

- A** Circuit board for relay box (diagram)
 - B** Sauna bus
 - C** Sensor bus
 - D** Reserve
 - E** Humidity sensor
 - F** Bench sensor
 - G** Heater sensor and safety temperature limiter
 - H** EmoTouch 3 control panel
 - I** Cabin lighting
 - J** Fan
 - K** Output controller
 - L** Vaporiser
 - M** Sauna heater
- optional

Schematic view of connections

In addition to the control panel, another module can be connected to the **B** jacks for the sauna bus.

4.2 Connections

The relay box is connected with a live current of 400 V 3 N AC 50 Hz and fused separately with 3 x 16 A. A 16 A cut-out with at least K characteristic must be used for fuse protection.

As a rule, only a fixed connection may be connected to the mains supply, whereby a configuration is provided that makes it possible to separate the system from the mains supply with a contact opening width of at least 3 mm (all poles).

4.2.1 Sensors

The temperature/humidity in the sauna cabin is set via the control panel. The set values are checked by sensors and controlled by the relay box. The sensors are connected to the RJ10 sensor jacks using RJ10 plugs. Each sensor can be connected to any one of the three jacks. The connected sensors are automatically detected by the control unit.

Humidity sensor

The (optional) humidity sensor regulates the relative air humidity in %. At the same time, the control unit attempts to keep the set humidity as precisely as possible.

The humidity sensor regulates the humidity according to the following indicated characteristic curve:

- All values that lie below or on the characteristic curve can be set and used.
When setting a parameter, e.g. temperature, the setting for the other parameter (humidity) is automatically adjusted.
- Values that lie above the characteristic curve cannot be set.

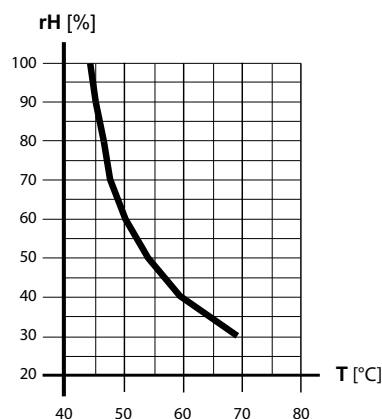

 Characteristic curve for temperature/humidity according to EN 60335-2-53

If no humidity sensors are used, the humidity is regulated in proportion to time.

Electrical installation

For example, the humidity setting = 40 means the vaporiser is on approx. 40 % of the total operating time.

This setting does not take into consideration the actual humidity in the sauna cabin and makes it possible to consistently produce a specific volume of steam.

If no humidity sensors are used, the vaporiser must be set up in relation to the cabin size in such a way that the limit curve is not exceeded when there is maximum steam.

Temperature control via heater sensor and/or bench sensor

The heater sensor (main sensor) controls the temperature in the sauna cabin. You can improve heat distribution in very large saunas where air circulation is a challenge by using an additional bench sensor.

In this case, the heater sensor does not control the sauna temperature, but acts as a temperature limiter (above approx. 120°C) to prevent overheating and the triggering of the safety temperature limiter in the event of a malfunction. Here, the bench sensor regulates the temperature.

If the bench sensor fails, the heater sensor regulates the temperature.

Circuit board connections

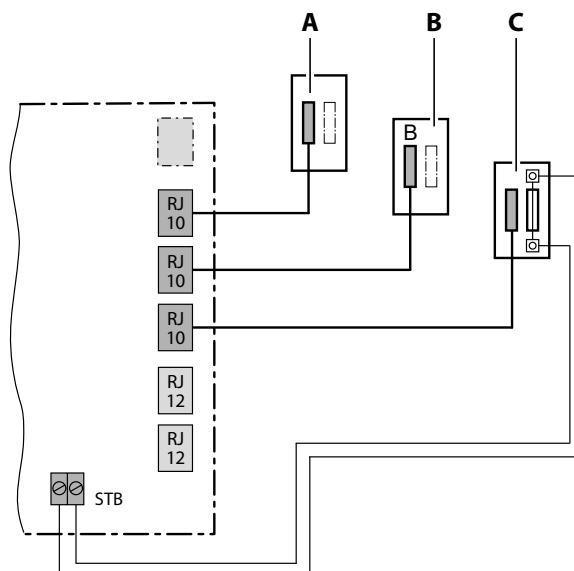

A Humidity sensor

B Bench sensor

 RJ10 connections for sensor

C Heater sensor (main sensor)

Set the desired values for the temperature and humidity on the control panel.

4.2.2 Terminals

All lines must be connected to the corresponding terminals. Heat-resistant cables must be used for the light, fan, and vaporiser connections.

Safety temperature limiter

NOTICE

Equipment damage due to improper installation

Additional modules can be mounted in a cabin.

- ▶ Connect the safety temperature limiter only to the relay box.
- ▶ Always connect the safety temperature limiter as an isolated contact.
- ▶ If the installation uses multiple sauna heaters, multiple safety temperature limiters may be required. Observe the separate EOS instructions.

The safety temperature limiter's white cable from the main sensor (heater sensor) is connected to the safety temperature limiter terminals.

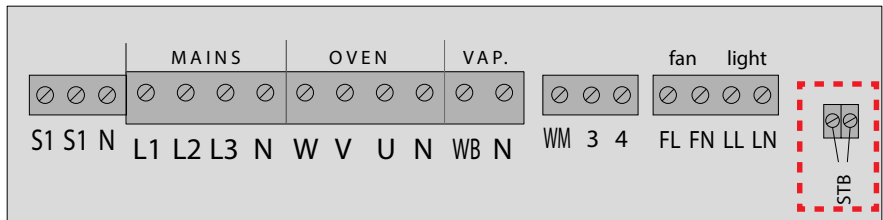

☒ Safety temperature limiter connection

Light and fan

The terminals for *light* and *fan* may each be occupied by one cable.

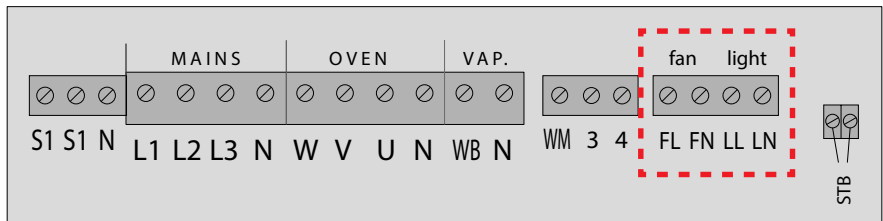

☒ Connection for light and fan

The terminals for *light* may be used only for cabin lighting. A fan with 5 W to 150 W may be connected to the *fan* terminal. The fan may not have a starting capacitor. Fan and light connections are protected by a joint 2AF fuse.

Electrical installation

Vaporiser (optional)

A heat-resistant cable must be used to connect the vaporiser. It must have a cross-section of at least 1.5 mm².

You can connect more than one vaporiser. If correctly connected, each vaporiser can report a water shortage separately. See [Checking for proper installation of the vaporiser](#), [EN-41](#).

⚠ WARNING

Fire hazard from overheating

If the connection for the water bath (*WB*) and water shortage (*WM*) are swapped, the thermostat is jumpered. The water shortage cannot be detected. The vaporiser overheats.

- ▶ Do not swap the connections for the water bath (*WB*) and water shortage (*WM*).
- ▶ Check for proper functioning after installation.

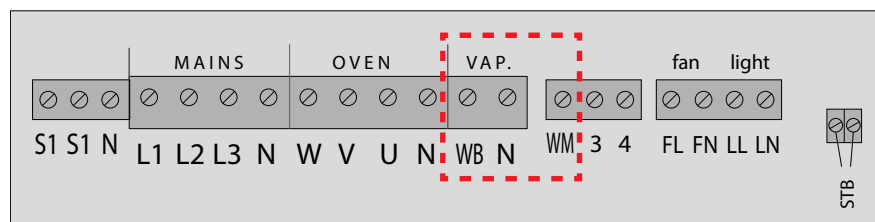

 Vaporiser connection

The control unit detects the water shortage if there is zero potential at the WM input of the control unit.

Note the following when connecting a vaporiser:

- The neutral conductor (N) of the vaporiser must be connected.
- Observe the maximum switching output of the vaporiser outlet.

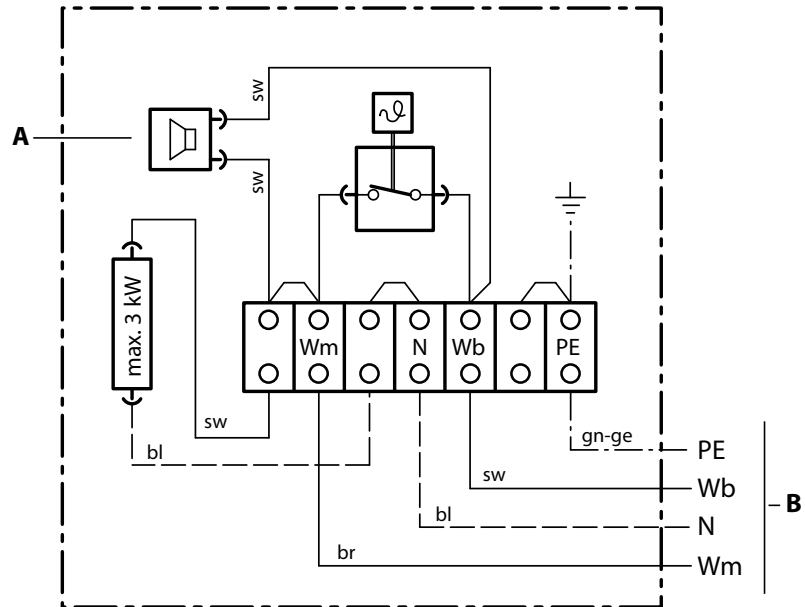

- bl** Blue
- sw** Black
- br** Brown
- gn-ge** Green-yellow
- A** Audible alarm from vaporiser
- PE** Ground potential
- Wb** Vaporiser outlet
- N** Neutral conductor
- WM** Water shortage
- B** Lines to relay box

☒ Connection diagram for vaporiser

If the entire output of the vaporisers to be connected exceeds the maximum switching output (3 kW) of the vaporiser outlet, an additional output controller must be connected to terminals S1/N/V on the relay box's circuit board, e.g. LSG18H.

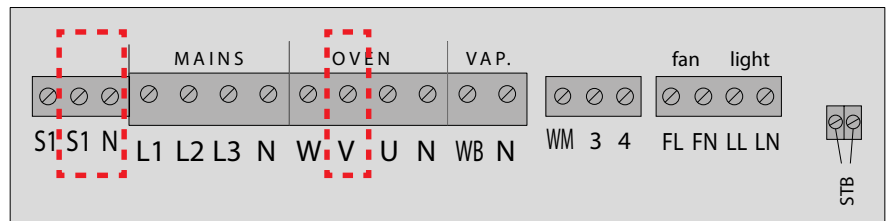

☒ LSG connection

Checking for proper installation of the vaporiser

If installed properly, the vaporiser will switch on and off according to the humidity setting.

- If the *Wb* and *Wm* connections on the vaporiser are swapped, the vaporiser will not switch off and continue to run uninterrupted.
- If the line to *Wm* is disconnected, the *Water shortage* error message has to appear.

Electrical installation

Sauna heater

The neutral conductor (N) of the sauna heater must always be connected because, in humidity mode, one phase is rerouted from the sauna heater to the vaporiser. This results in an asymmetrical heating load and power flows through the neutral conductor.

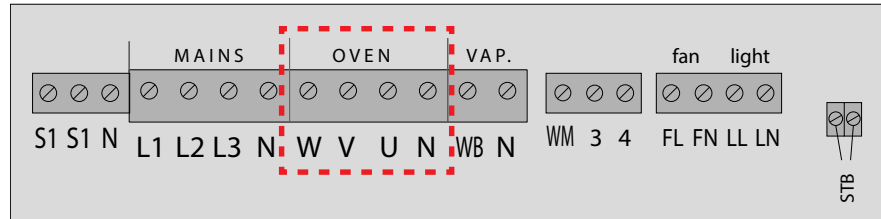

The switching output of the control unit for the sauna heater has a max. of 9 kW resistive load. It can be expanded as needed by an optional output controller (LSG) so that it is possible to connect sauna heaters with an output greater than 9 kW.

To connect the optional LSG, see the installation instructions for the relevant LSG.

4.3 Setting the jumper for maximum heating time

The sauna heater's heating time is limited during installation by the jumper plug. The actual runtime can be adjusted on the control panel when making this jumper setting.



Runtime of max. 6 h for private use



Runtime of max. 12 h for commercial use without monitoring



Runtime of max. 18 h for commercial use without monitoring



Runtime of 24 h for 7 days

For this setting, the heating time must be switched off manually.

The setting is permitted only if the sauna is used commercially and monitored.

The jumpers are included with the device and are connected by blind plug-in.

► **Setting JP5 for heating time**

- 1 **WARNING!** Ensure that the relay box has no power.
Open the housing.
① ► Removing the housing cover, ① EN-25

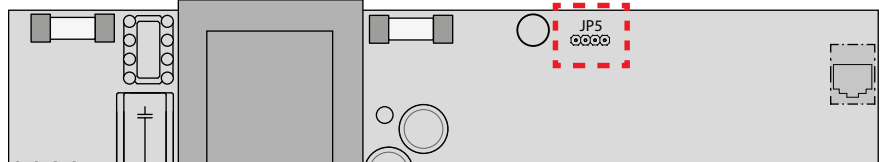

- 2 Set jumper JP5 to the desired runtime.

4.4 Connecting data lines

► **Connecting data lines**

- 1 **WARNING!** Ensure that the relay box has no power.
Open the housing.
① ► Removing the housing cover, ① EN-25
- 2 Route the line through the openings at the base or on the back of the housing.



A RJ10 plug for sensor line **B** RJ14 plug from control panel

- 3 Plug the S-Bus line RJ10/RJ14 from the control panel into the free jack RJ12 (S-BUS).
① Connect shielding of the line to ground if necessary.

- 4 Plug the sensor lines for the sensor into the free jack RJ10 (SENSOR).
 - ① The connected sensors are automatically detected and must be configured on the control panel.
 - ① In a multi-cabin installation, the cabin address must also be programmed. See 6.3 Programming of the cabin address, [EN-64](#)
 - ① Do not establish a connection to the power supply until you have connected all lines and set all jumpers.

4.5 Connecting and configuring consumers



⚠ WARNING

Risk of electric shock

A faulty electrical connection poses the risk of an electric shock. This risk remains also after completion of the installation work.

- ▶ Disconnect the system entirely from the mains supply.
- ▶ If retrofitting is required, the housing must only be opened by trained personnel.
- ▶ Electrical installation must only be carried out by a qualified and licensed electrician.
- ▶ The unit must be connected to the power supply according to the circuit diagram and the terminal scheme.

Recommended sequence:

- Connect the cabin lighting
- Connect the fan
- Connect the vaporiser if necessary
- Connect the sauna heater

The entire output of the connected devices may not exceed the following values:

- For information about cabin lighting, see [Light source requirements](#); [EN-21](#).
- For information about the fan, see [Fan requirements](#), [EN-22](#).
- Vaporiser 3 kW
- Sauna heaters 9 kW

If the entire output exceeds these values, an additional output controller must be connected, e.g. LSG18H. See the installation instructions for the relevant LSG.

► Connecting consumers

1 WARNING! Ensure that the relay box has no power.

Open the housing.

① ► Removing the housing cover, □ EN-25

2 Route the lines through the openings at the base or on the back of the housing.

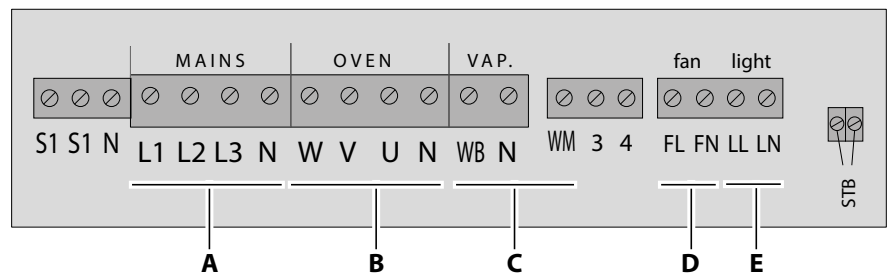

3 Connect the cabin lighting to the **(E)** terminals.

4 Connect the fan to the **(D)** terminals.

5 Connect the vaporiser to the **(C)** terminal if necessary.

① Note the total output of the vaporiser outlet: max. 3 kW.

6 Connect the sauna heater to the **(B)** terminals.

① In humidity mode: Ensure that the neutral conductor (N) of the sauna heater is always connected because, in humidity mode, one phase is rerouted from the sauna heater to the vaporiser. This results in an asymmetrical heating load and power flows through the neutral conductor.

① Note the switching output of the heater: max. 9 kW.

7 Connect the mains connection to the **(A)** terminals.

4.6 Connecting the potential-free contact

- 1 **WARNING!** Ensure that the relay box has no power.
Open the housing.
 ⓘ ► Removing the housing cover, [EN-25](#)
- 2 Route the lines through the openings at the base or on the back of the housing.

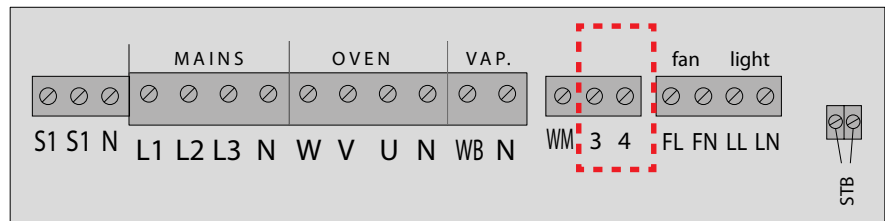

- 3 Close the housing again.

4.7 Closing the relay box housing

The following work must be completed before you close the housing:

- 4.4 Connecting data lines, [EN-43](#)
- 4.3 Setting the jumper for maximum heating time, [EN-42](#)
- 4.5 Connecting and configuring consumers, [EN-44](#)
- 6.3 Programming of the cabin address, [EN-64](#)

If the device is connected correctly and switched on, a green LED flashes on the main circuit board after a short start-up period. This green LED signals normal communication.

See chapter [Commissioning](#), [EN-48](#).

If the relay box in the plant room and the control panel are far apart, the technician can identify the correct installation.

► Remounting the housing cover

- 1 Switch on the relay box and check if the green LED is flashing.
 - a) If the green LED is flashing, remount the housing cover.
 - b) If the green LED is not flashing, troubleshoot the problem and resolve it.
- 2 First put the lower then the upper cover halves in place.
- 3 Screw in the 6 screws.

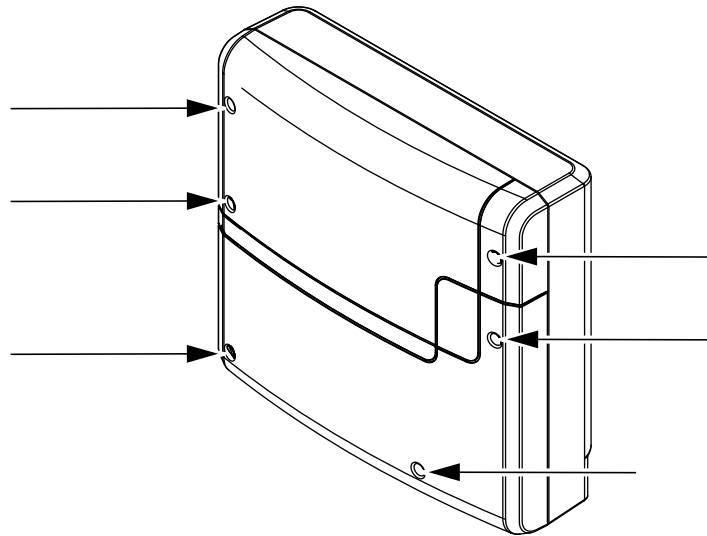

5

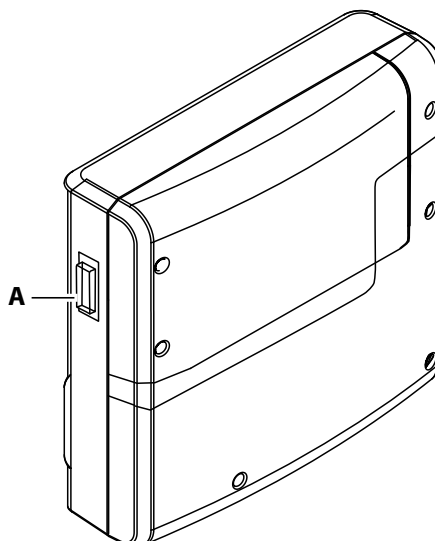
Commissioning**A** Unit switch on relay box

In order to commission the sauna cabin, the cabin must be switched on at the control panel. If the display is blank, the relay box might be switched off.

A unit switch is located on the left side of the relay box.

**Position I:**

Relay box is switched on (factory setting).

The relay box is ready for operation in standby mode.

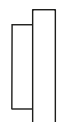
**Position 0:**

Relay box is completely switched off.

Parts of the circuit board are still under current.

**Position II:**

Cabin lighting is switched on, relay box is switched off.

Position for maintenance and cleaning.

5.1 Operation basics

All cabin settings are made at the control panel.

All functions must be configured to commission the system.

Add-on modules or accessories are detected after the unit is switched on again and their corresponding icons appear in the sub-menus.

5.1.1 User interface icons

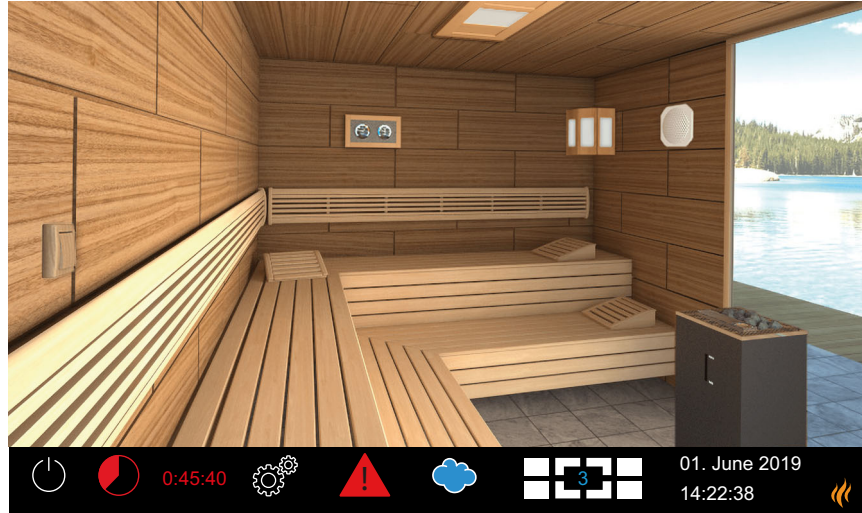

EmoTouch 3 control panel (example)







The touch screen icons are displayed in various colours:

- Grey: Function button is inactive
- White: Function available or selected
- Green: Function button Confirm is selected
- Blue: Settings, e.g. for timer
- Red: Function button Delete is selected, icon for auto-stop

Texts are displayed in the following colours:

- White: Status texts, e.g. date, name of sub-menu
- Blue: active input digits, e.g. for date, time, timer display
- Red: Warning, time display for auto-stop

Operating and status icons (examples)

	System on/off		Settings
	Malfunction warning		Current cabin (only for multi-cabin installation)
	Humidity mode		Confirmation prompt

A complete description of the icons and settings can be found in the operating instructions.

Commissioning

5.1.2 Switching on and off

The control panel automatically switches to standby mode once connection to the relay box has been established and it is connected to the mains supply.

Choose  to switch heating on or off.

5.2 Setup during commissioning or after a reset

The settings must be redefined upon commissioning and after a complete system reset. The program guides you through the required steps.

► Defining the basic settings



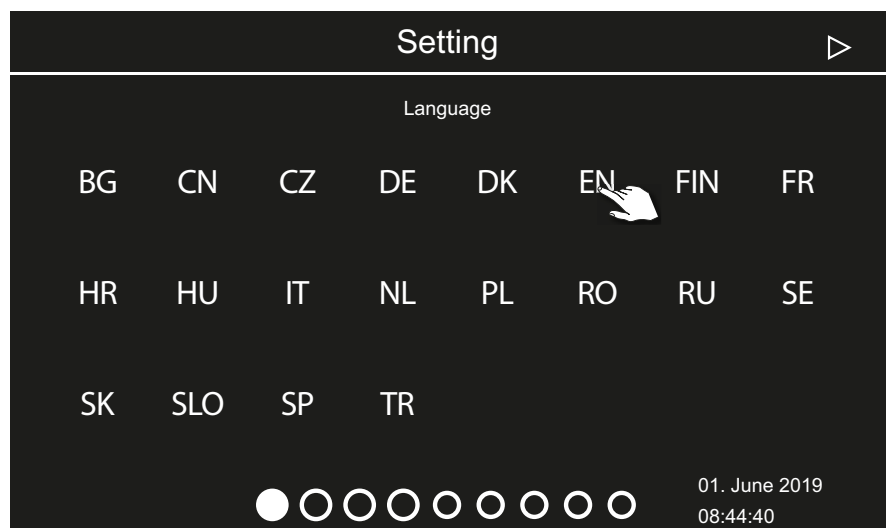

- 1 Tap the desired language.

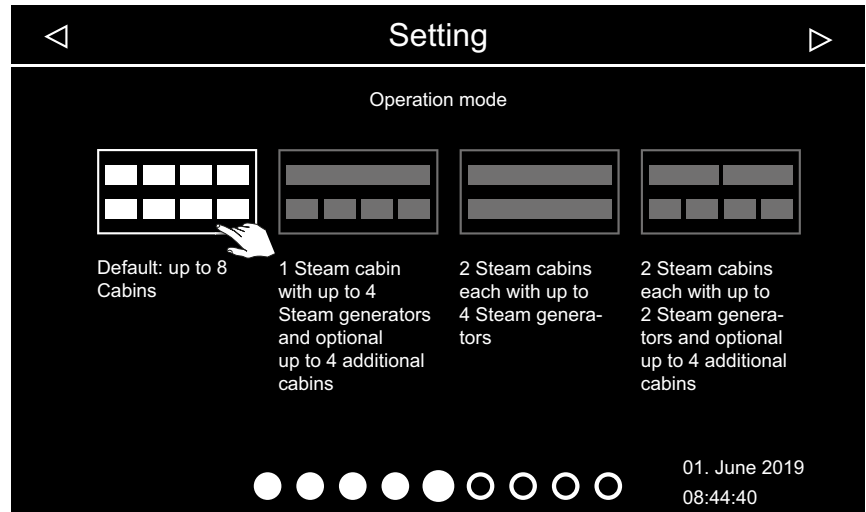

- 2 Confirm the selection.
 - The display now shows settings for the time.
- 3 Set the time and confirm.
- 4 Set the date and confirm.
- 5 Specify and confirm the place of operation.
 - ① European Union/CENELEC must be selected if the system is installed in countries under the jurisdiction of the CENELEC.

6 Select the operating mode and confirm.



- ①  Choose this setting if one steam generator or one sauna heater per cabin is controlled. For more information about installing multiple cabins, see [Installing multiple cabins](#), [EN-56](#).
- ①  Choose this setting if one cabin is served by 1–4 steam generators. Additionally, 4 more cabins can be controlled with steam generators or sauna cabins.
- ①  Choose this setting if 2 cabins, each with up to 4 steam generators, are operated.
- ①  Choose this setting if 2 steam room cabins, each with up to 2 steam generators, are operated. Additionally, 4 sauna cabins or IR cabins can be operated.

7 Specify the type of use and confirm:

- a)  Private use
- b)  Commercial use

① Specific safety regulations apply to this setting. See [1.2 Operator instruction](#), [EN-6](#)

8 Confirm the confirmation prompt.

① If you do not confirm the safety device, the settings for the remote start module, the Web App WCI module and the timer are deactivated.

9 Select the heater type and confirm.

Commissioning

10 Open skin selection by pressing .

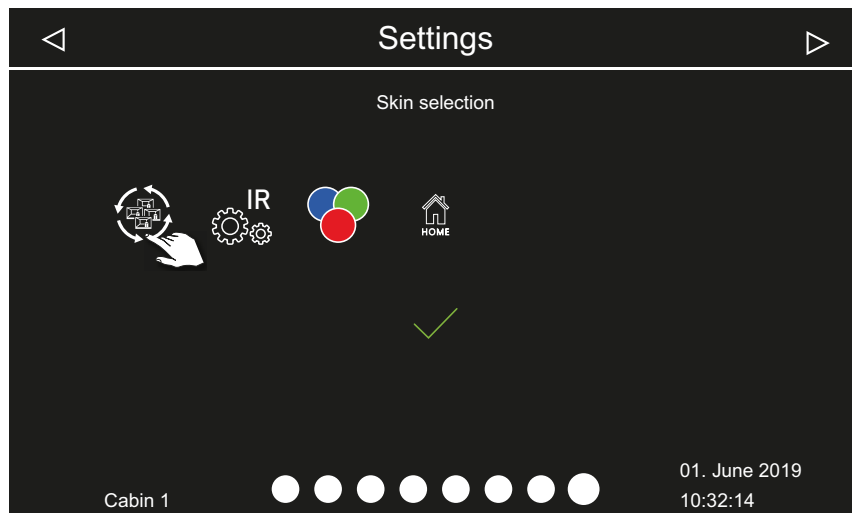

11 Select the skin and confirm.

12 Select the sauna heater display and confirm.



- ① After selecting the heater display, the selection of the connected modules is displayed again.
- ① If the installation is a multi-cabin installation, the skin, the heater display and the module for each cabin is set.

5.3 Defining the light source manually

The control unit is set to inductive loads by the factory so that resistive loads can also be controlled by the control panel. If required, the light output can also be manually set to capacitive loads. For this, the lighting must be disconnected.

If light bulbs are used, the load for lighting must remain as an inductive load.

The current setting is shown on the display when the lighting is dimmed.

Display symbol	Setting	Code
	Inductive/resistive load (lighting for phase control), if light bulbs are used. Factory setting	8001
	Capacitive load (lighting for phase control) Electrical ballasts for phase-cut dimmer	8002

NOTICE

Material damage

Improper setup can damage the unit. In this case, the warranty becomes void.

- ▶ Work must only be performed by a trained technician from an authorised company specialised in the trade.

For this setting, the lighting must be disconnected.

▶ Setting the load for lighting to resistive load

- 1 **WARNING!** Ensure that the relay box is disconnected from the power supply.
Open the relay box's housing.
① ▶ Removing the housing cover, [EN-25](#)
- 2 Disconnect the light source's connecting cable from the relay box.
- 3 Reconnect the power supply and switch on the relay box and control panel.
- 4 Press and hold  for 3 seconds.
- 5 Enter the code and confirm.

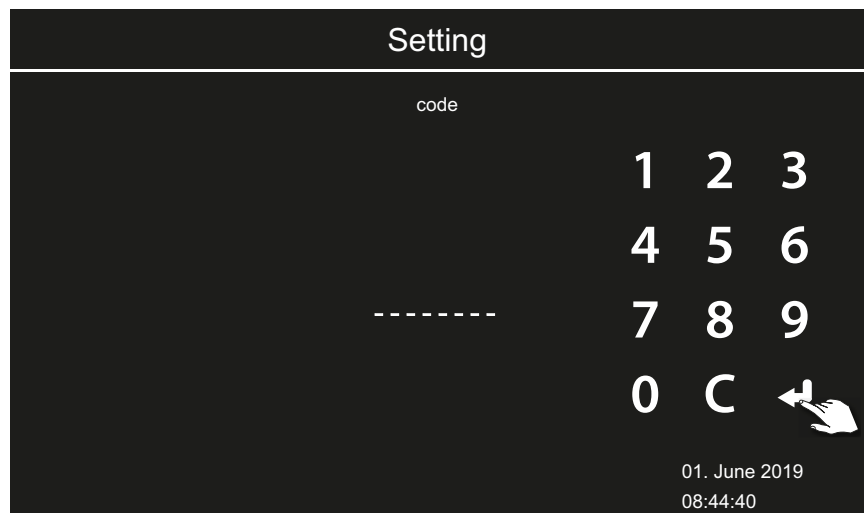

- ① Code **8001**: Inductive load/resistive load, e.g. if light bulbs are used.
- ① Code **8002**: Capacitive load.

- 6 Disconnect the relay box from the mains supply and reconnect the light source.

Commissioning

- 7 Close the housing again.
① 4.7 Closing the relay box housing, [EN-46](#)
- 8 Reconnect the relay box to the power supply and switch it on.
- 9 Press and hold the light icon on the display for 3 seconds.



- ① The icon for the current lighting load setting is displayed.

- 10 Check the setting on the display.

5.4 Troubleshooting

Error messages and icons on the control panel indicate operating statuses and fault conditions.

Error – error message	Reason	Solution
Display is blank	No power supply.	Switch on the relay box. Check the relay box's mains connection. Check fuses.
	No connection to the relay box.	Check the connection to the control panel.
	A connecting cable > 25 m to the control panel and power adapter is missing.	Check the power adapter; a cable is required if the distance is 25 m or longer.
	Safety temperature limiter triggered.	Temperature too high. Check cause of excess temperature. Replace the safety temperature limiter.
Temperature sensor fault	No connection to the temperature sensor.	Check the cable and connections.
	Sensor is defective.	Replace the sensor.
Error with the safety circuit	No connection.	Check the cable and connections (broken cable, loose connection, etc.).
	Fuse tripped by excessively high temperature.	Check the cause of excess temperature and have the fuse for the safety temperature limiter replaced (a replacement fuse is included with the control unit).
Water shortage	Not enough water in the vaporiser.	Refill water. Install automatic filling, if necessary. Observe the set refill period, otherwise the system forces shut-off.
	Malfunction when automatically filling water.	Check water supply. Check mains water connection FWA01 device. Clean the filter at the water supply connector if necessary.
	No water supply, water inlet valve clogged, blocked, or defective.	Clean the water inlet valve and check that it functions properly. Replace the water inlet valve if necessary.
No bus communication.	Too many add-on modules connected.	Connect modules with separate power adaptor.
	Bus connection plug not plugged in.	Plug in plug.
	Bus cable damaged.	Replace bus cable.
	Unit not detected.	Set unit address for the module.
Other errors	Software error.	Restart unit. Contact technical support.

Installing multiple cabins

6

Installing multiple cabins

The EmoTouch 3 control panel can be used to set and control multiple cabins. Any combination of up to 8 sauna, infrared and/or steam cabins can be connected, e.g.:

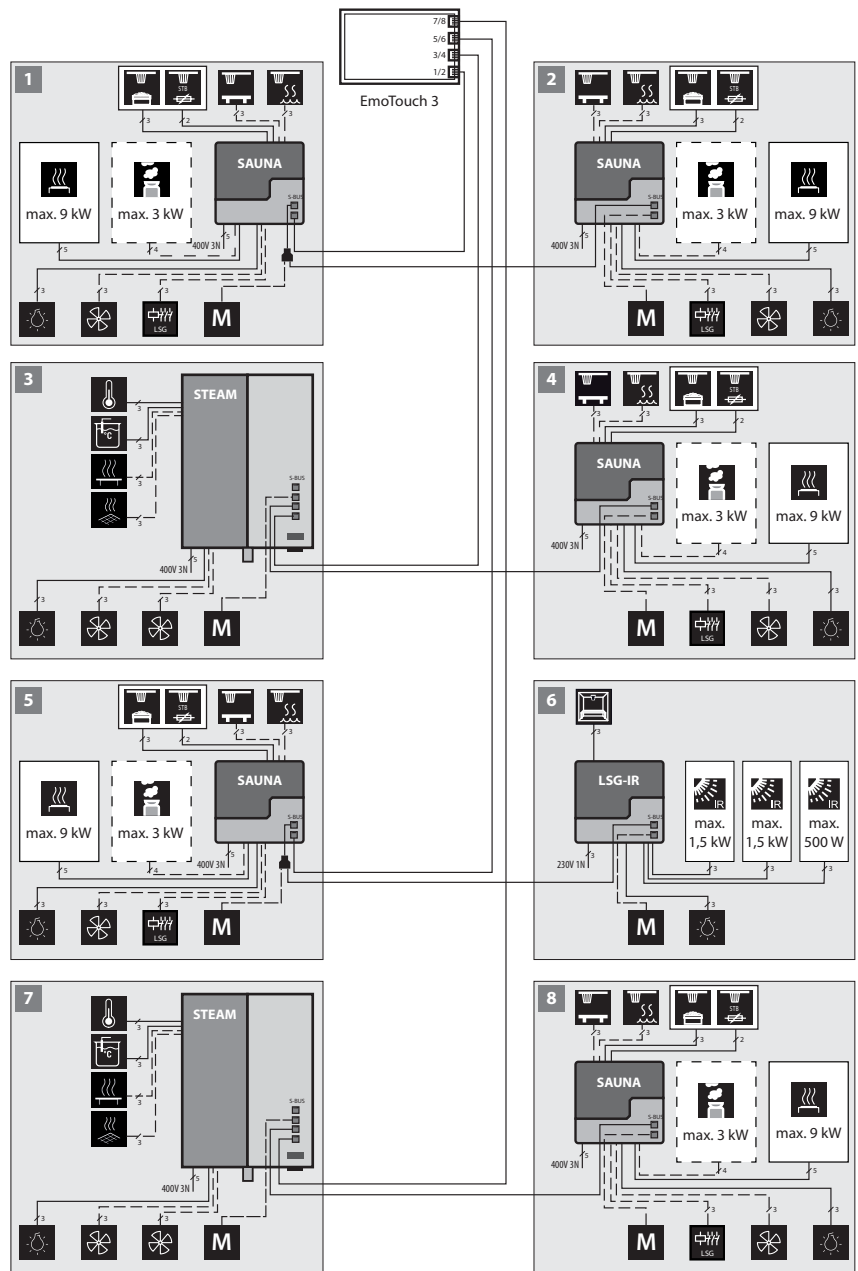

LSG-IR Infrared relay box



Sauna heater



Vaporiser



Modules

6.1 Configuration options

To control multiple cabins with one EmoTouch 3 control panel, you must connect, program, and set up the cabins and relay boxes accordingly. The lines must be connected according to the operating mode that is selected at the time of startup.

A unique cabin address must be programmed for each relay box.

Furthermore, in a mixed multi-cabin installation, a unique cabin address must be programmed for each steam generator.

The connections and the cabin addresses are shown in detail in the following chapters.

- 6.1.1 Configuring 1–8 sauna cabins, [EN-58](#).
- 6.1.2 Configuration 2 – 1 steam room and 4 additional cabins, [EN-59](#).
- 6.1.3 Configuring 3–2 steam rooms, [EN-60](#).
- 6.1.4 Configuration 4 – 2 steam room cabins and 4 additional cabins, [EN-61](#).

Installing multiple cabins

6.1.1 Configuring 1–8 sauna cabins

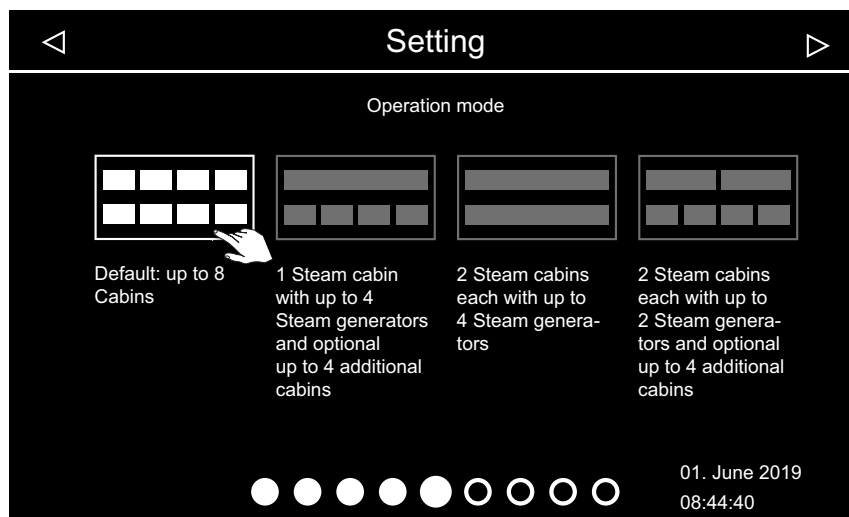

 Operating mode – standard





 In this configuration, one steam generator or one sauna heater is operated per cabin.

The lines are connected as follows:

Cabin no.	Relay box connection – control panel	Cabin address
1	The relay box is connected to jack #1 of the control panel using the sauna bus cable.	Relay box remains set to address 1.
2	The relay box is connected to a free sauna bus jack in the relay box of cabin #1.	Relay box is set to address 2.
3	The relay box is connected to jack #2 of the control panel using the sauna bus cable.	Relay box is set to address 3.
4	The relay box is connected to a free sauna bus jack in the relay box of cabin #3.	Relay box is set to address 4.
5	The relay box is connected to jack #3 of the control panel using the sauna bus cable.	Relay box is set to address 5.
6	The relay box is connected to a free sauna bus jack in the relay box of cabin #5.	Relay box is set to address 6.
7	The relay box is connected to jack #4 of the control panel using the sauna bus cable.	Relay box is set to address 7.
8	The relay box is connected to a free sauna bus jack in the relay box of cabin #7.	Relay box is set to address 8.

All relay boxes are set by the factory to cabin address 1.

See also the following figures:

-  Jacks – sauna cabin relay box,  EN-62
-  Jacks – EmoTouch 3 circuit board,  EN-62

6.1.2 Configuration 2 – 1 steam room and 4 additional cabins

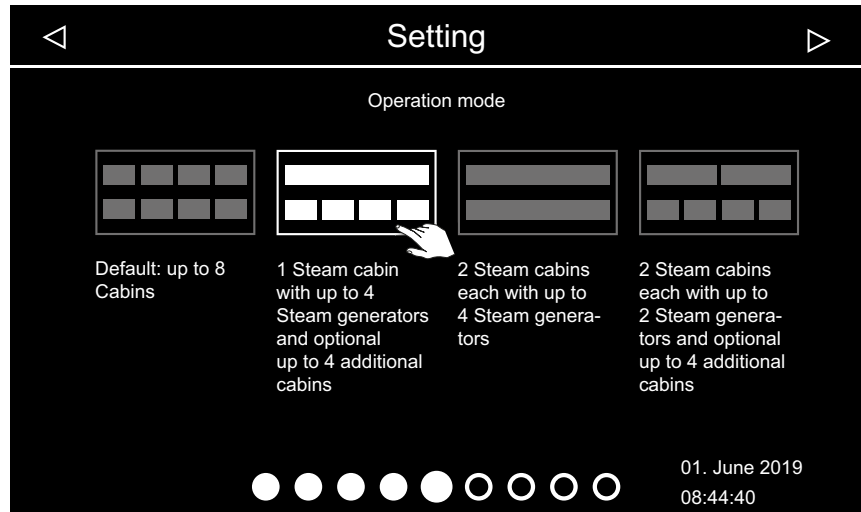





 Operating mode – 1 steam room and max. 4 sauna or IR cabins

 In this configuration, one cabin is controlled with 1–4 steam generators. Additionally, 4 more cabins with sauna heaters or infrared emitters can be controlled.

Regardless of the number of steam generators in the first cabin, the second cabin must be connected to jack 3 on the control panel. Cabin address 5 must be programmed at the corresponding steam generator or relay box. Additional cabins are connected and programmed as follows:

Cabin	Steam generator/module*	Cabin address	EmoTouch 3 jack	
First cabin	First steam generator	1	1	Required
	Second steam generator	2	1	Optional
	Third steam generator	3	2	Optional
	Fourth steam generator	4	2	Optional
Second cabin	1 steam generator or module	5	3	Optional
Third cabin	1 steam generator or module	6	3	Optional
Fourth cabin	1 steam generator or module	7	4	Optional
Fifth cabin	1 steam generator or module	8	4	Optional

* Module = add-on modules, e.g. LSG-Sauna, LSG-IR, LSG-RB, etc.
See also the following figures:

-  Jacks – sauna cabin relay box,  EN-62
-  Jacks – EmoTouch 3 circuit board,  EN-62

Installing multiple cabins

6.1.3 Configuring 3–2 steam rooms

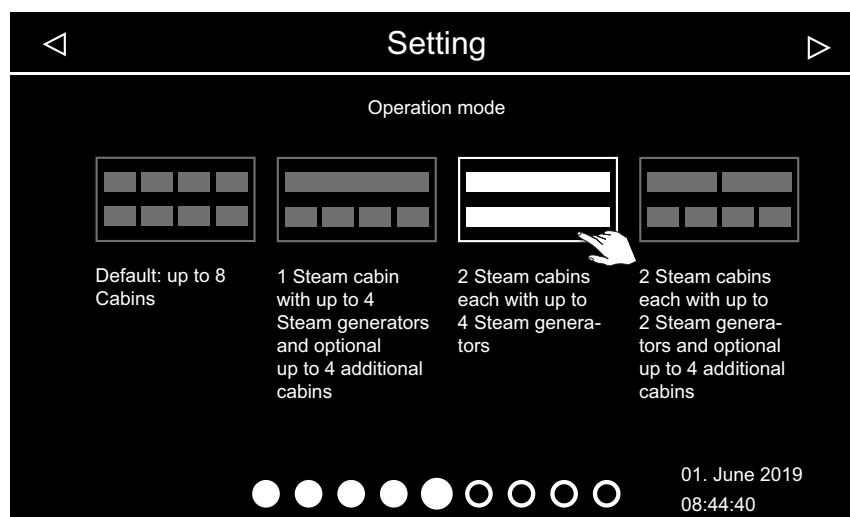





 Operating mode – 2 steam rooms with 2–4 steam generators

 In this configuration, 2 cabins are controlled with 2–4 steam generators. Additional cabins require their own control unit.

Cabin	Steam generator	Cabin address	EmoTouch 3 jack	
First cabin	First steam generator	1	1	Required
	Second steam generator	2	1	Optional
	Third steam generator	3	2	Optional
	Fourth steam generator	4	2	Optional
Second cabin	First steam generator	5	3	Required
	Second steam generator	6	3	Optional
	Third steam generator	7	4	Optional
	Fourth steam generator	8	4	Optional

See also the following figures:

-  Jacks – sauna cabin relay box,  EN-62
-  Jacks – EmoTouch 3 circuit board,  EN-62

6.1.4 Configuration 4 – 2 steam room cabins and 4 additional cabins

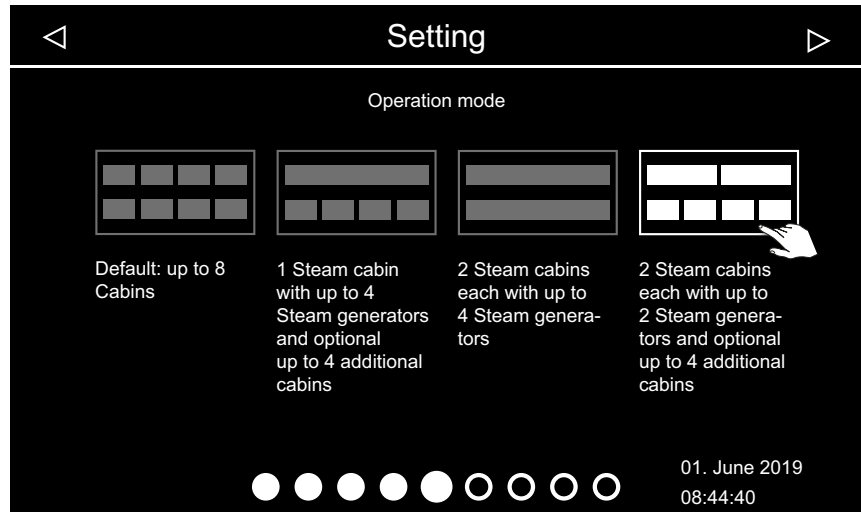





 Operating mode – 2 steam rooms with 1–2 steam generators and max. 4 additional cabins

 In this configuration, two cabins with 1–2 steam generators each and up to 4 additional cabins are operated.

Cabin	Steam generator/module*	Cabin address	EmoTouch 3 jack	
First cabin	First steam generator	1	1	Required
	Second steam generator	2	1	Optional
Second cabin	First steam generator	3	2	Required
	Second steam generator	4	2	Optional
Third cabin	Module	5	3	Optional
Fourth cabin	Module	6	3	Optional
Fifth cabin	Module	7	4	Optional
Sixth cabin	Module	8	4	Optional

* Module = add-on modules, e.g. LSG-Sauna, LSG-IR, LSG-RB, etc.
See also the figures for configuration 1:

-  Jacks – sauna cabin relay box,  EN-62
-  Jacks – EmoTouch 3 circuit board,  EN-62

Installing multiple cabins

6.2 Control lines and cabin addresses

Control lines must only be plugged into the corresponding jacks on the circuit boards of the steam generator and relay boxes.

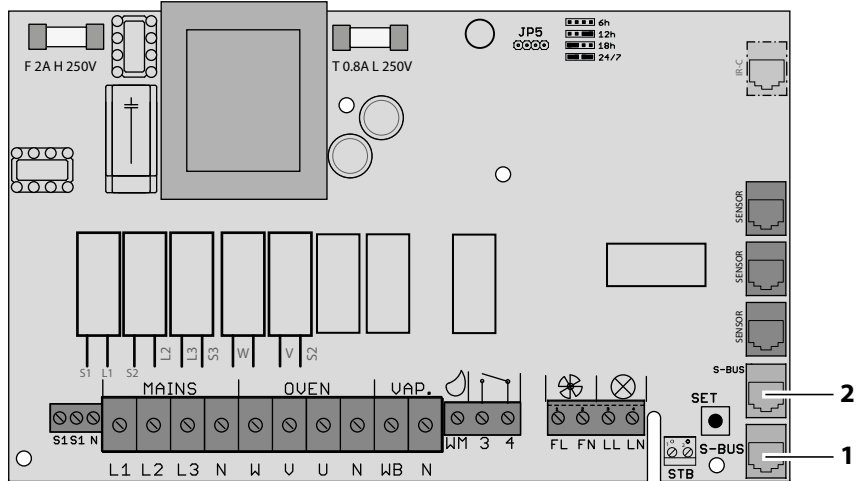

□ Jacks – sauna cabin relay box

The relay boxes for steam room or IR cabins are described in detail in separate instructions.

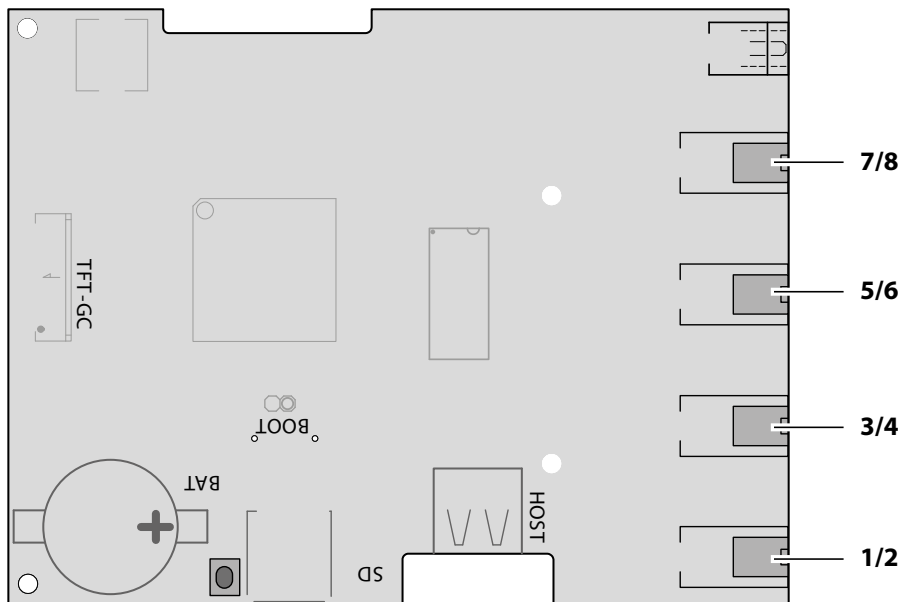

□ Jacks – EmoTouch 3 circuit board

Ferrite ring per jack

NOTICE

Malfunctions in other electronic devices

Electromagnetic emissions (interference signals) can adversely impact other electronic devices.

- ▶ Pull each connecting cable through its own ferrite ring twice per jack.

One jack per connection must be fitted with 1 ferrite ring. The connecting cable must be pulled through the ferrite ring twice.

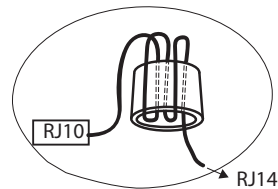

The ferrite ring for jack #1 is included in the scope of delivery for each control panel and add-on module.

Once the cabins with their custom cabin address (IDs) are connected, the icon for the selected cabin is displayed in the footer.



The number corresponds to the cabin currently selected (not the number of connected cabins).

Installing multiple cabins

6.3 Programming of the cabin address

The EmoTouch 3 relay box is programmed with cabin address 1 as delivered. To ensure that EmoTouch 3 detects multiple cabins, the cabin address must be changed to a different cabin address starting with cabin 2.

See more about the various configurations: 6.1 Configuration options, [EN-57](#)

Programming button on the circuit board

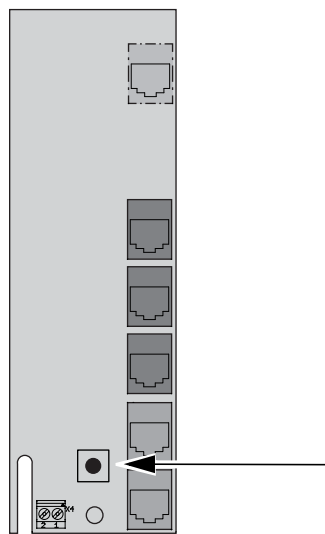

 Programming button – relay box

6.4 Setting up a multi-cabin installation

To program the cabin addresses, you must open the housing of the control panel and of the relay box.

See chapter Installation, [EN-15](#).

Ensure that you observe the connection sequence.

The connection sequence must start with jack #1 on the control panel's circuit board. See 6.1 Configuration options, [EN-57](#).

The control lines can be connected via the relay box or directly in the control panel. The cabin with address 4 can be connected as follows, for example:

- Via the relay box of cabin 3, which is then connected to jack #2 of the control panel.
- Directly to jack #2 of the control panel.

In both cases, cabin 4 is finally connected to jack #2. Cabins with incorrect connections will not be detected or displayed on the control panel.

The following describes how you set up the multi-cabin installation for configuration 1. Proceed as described in configuration 2–4 and ensure that the cabin addresses are correct.

NOTICE

Cabin is not detected by the control panel

In the multi-cabin installation, the cabin address must match the connection of the S-Bus connections on the circuit board of the EmoTouch 3 control panel.

- ▶ Observe the correct S-Bus connection sequence.
- ▶ Ensure the cabin address is correct.

-
- ▶ Plug in the S-Bus lines, [EN-65](#)
 - ▶ Programming addresses, [EN-66](#)

▶ **Plug in the S-Bus lines**

- 1 Open the housing of the relay box and control panel.
 - ① 3.3.2 Installing the relay box, [EN-25](#)
 - ① 3.4.2 Mounting the control panel, [EN-29](#)
- 2 **NOTICE** The connection must always start with jack #1. The connection sequence must be adhered to exactly.
Plug the relay box for cabin 1 into jack #1 on the control panel.

Installing multiple cabins

- 3 Plug the relay box for cabin 2 into jack #2 on the relay box for cabin 1.

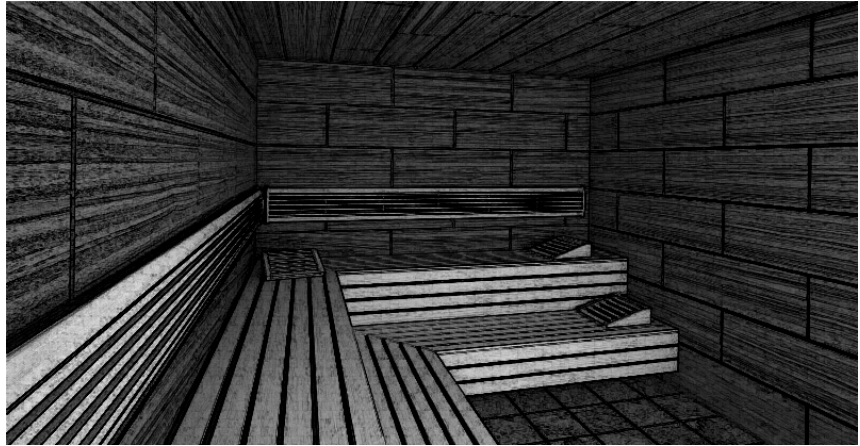

- ① EmoTouch 3 automatically switches to multi-cabin mode. On the display, the new cabin in grey is displayed until the cabin address has been programmed.
 - ① The cabin address can be programmed once all lines have been plugged in, see ► Programming addresses, EN-66.
- 4 Plug the relay box for cabin 3 into jack #2 on the control panel.
 - 5 Plug the relay box for cabin 4 into jack #2 on the relay box for cabin 3.
 - 6 Plug the relay box for cabin 5 into jack #3 on the control panel.
 - 7 Plug the relay box for cabin 6 into jack #2 on the relay box for cabin 5.
 - 8 Plug the relay box for cabin 7 into jack #4 on the control panel.
 - 9 Plug the relay box for cabin 8 into jack #2 on the relay box for cabin 7.
 - ① Once all lines have been plugged in, the cabin addresses must be de-programmed.

► Programming addresses

- 1 **NOTICE** You must follow the correct connection sequence in the EmoTouch 3 control panel.
If the cabin address does not match the connection, the cabin is not detected.
- 2 Press and hold the programming button on the circuit board of relay box 2 for approx. 5–6 seconds until the red LED illuminates.
 - Programming mode is then active. The green LED light goes off.
- 3 Briefly but firmly press the programming button once.

- 4** Wait until the green LED flashes and count how many times it flashes.
 - ☑ The green LED flashes 1 to 8 times, depending on the new cabin address. E.g. for cabin 2, the LED flashes twice.
- 5** Repeat steps **3** and **4**, until the desired cabin address has been set.
 - ① Note that each time you press the programming button, the cabin address increases by one. Once address 8 is reached, the count starts over with address 1.
 - ☑ If the button is not pressed for approx. 15 seconds, programming mode ends. The red LED goes off and the green LED starts flashing. The new address is saved.
- 6** Check if the new cabin is shown on the display.
 - ☑ In the status bar, the icon for multi-cabin operation appears:

 - ☒ Example – display for cabin 3
 - ☑ On the display, the image changes from the large cabin image to a black background with small cabin icons.
 - ① If the small cabin icon is displayed in grey, the cabin has not been detected. Check the cabin address and the connection sequence on the EmoTouch 3 control panel.
- 7** Repeat programming if the cabin is not displayed.
 - ① Please note that the address increases by one each time you press the programming button, e.g. from 4 to 5.
- 8** Close the housing of the relay box and control panel.
 - ① ► Plugging in the control panel, [EN-33](#)
 - ① ► Remounting the housing cover, [EN-46](#)

Now you can make the settings for each cabin.

► Defining the basic settings, [EN-50](#)

For information on cabin settings, see the separate operating instructions.

7

General terms and conditions of service

(T&C, Dated 08-2018)

I. Scope

Unless otherwise agreed in writing for specific instances, these terms and conditions of service shall apply to service operations, including reviewing and remedying complaints. All our existing or future legal relationships shall be governed solely by the following terms and conditions of service. We do not recognise any of the customer's conflicting terms and conditions unless we have given our express written consent to their applicability.

We hereby expressly object to any of the customer's terms and conditions included in the customer's General Terms and Conditions of Business or order confirmation. Unconditional acceptance of order acknowledgments or deliveries shall not be construed as any form of acknowledgment of such terms and conditions. Ancillary agreements or amendments must be confirmed in writing.

II. Costs

The customer shall bear the following costs in connection with services rendered:

- Mounting/dismantling and electrical (de-)installation
- Transportation, postage and packaging
- Function testing and troubleshooting, including inspection and repair costs

There shall be no third-party billing.

III. Performance and cooperation obligations

The customer shall provide assistance free of charge to the manufacturer in rendering services.

In the case of a warranty claim, the manufacturer shall provide spare parts necessary for servicing free of charge.

IV. Service visit by the manufacturer

Services rendered on site by an employee of the manufacturer must be agreed in advance.

If the main reason for the service visit is not the fault of the manufacturer, any costs incurred shall be charged to the customer after the service visit and must be paid by the customer in full within the agreed payment term.

V. Liability

The manufacturer shall assume liability in accordance with the currently applicable statutory regulations. All our products are packaged in such a way that the individually packed goods (pallets) can be shipped.

We wish to point out that our packaging is not suitable for individual shipments via parcel post. The manufacturer shall accept no liability for damages incurred as a result of improper packaging in an individual shipment.

VI. Manufacturer's warranty

The manufacturer's warranty shall apply only if installation, operation and maintenance have been carried out in full accordance with the manufacturer's specifications in the installation and operating instructions.

- The warranty period shall commence from the date on which proof of purchase is provided and shall be limited, in all cases, to 24 months.
- Warranty services shall be performed only if proof of purchase of the equipment can be presented.
- Any and all warranty claims shall become void if modifications are made to the equipment without the manufacturer's express consent.
- Any warranty claim shall likewise become void in the case of defects that arise due to repairs or interventions made by unauthorised persons or due to improper use.
- In the case of warranty claims, the serial and article numbers must be provided, together with the unit designation and a meaningful description of the error.
- This warranty shall cover defective equipment parts, with the exception of normal wear parts. Wear parts shall include, for example, light sources, glass elements, tubular heating elements and sauna heater stones.
- Only original spare parts may be used within the warranty period.
- Service visits made by third parties shall require a written order issued by our service department.
- The equipment in question shall be sent to our service department by the customer at the customer's own expense.
- Electrical assembly and installation work, including service visits and parts replacements, shall be carried out at the customer's expense; costs shall not be borne by the manufacturer.

General terms and conditions of service

Complaints in respect of our products shall be reported to the responsible distributor and shall be handled exclusively by said distributor. The manufacturer's General Terms and Conditions of Business, in the version available at www.eos-sauna.com/agb, shall apply in addition to the foregoing terms and conditions of service.

8

Disposal

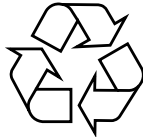

Electrical devices that are no longer needed must be recycled at a recycling station as per EU guideline 2012/19/EU or as per the Electrical and Electronic Equipment Act (ElektroG). Observe local provisions, laws, regulations, standards and directives when disposing of the unit.



Do not dispose of the unit with household waste.

Packaging

The packaging of the control unit can be completely separated for disposal and recycled. The following materials are used in the packaging:

- Used paper, cardboard
- Plastic foil
- Foam material

Electronic waste

Electronic waste must be disposed of at the designated local collection point for electronic waste.



Service address

EOS Saunatechnik GmbH

Schneiderstriesch 1

35759 Driedorf, Germany

Tel. +49 2775 82-514

Fax +49 2775 82-431

Email servicecenter@eos-sauna.com

Web www.eos-sauna.com

Store this address with the installation instructions in a safe place.
Please always provide us with nameplate data, such as model, item number and serial number so we can provide fast and efficient support.

Date of sale

Stamp/retailer signature: