

# HARVIA VIRTA

HL110400

The Harvia Virta heater's strong structure and exceptional ease of maintenance make it excellently suitable for those who use the sauna often and like to enjoy the steam for long periods of time.

## Advantages

- A reliable heater with sturdy structure for home sauna and professional use
- The large number of stones guarantees soft and abundant steam. Efficient air circulation heats the sauna very quickly
- Sleek and modern design
- The heating elements are separated from the stones, which results in a long heating element life span
- The maintenance hatch on the front enables quick and easy maintenance without touching the stones



## Features

Main material : Steel

H x W x D : 810.0 x 415.0 x 485.0 mm

Net weight (kg) : 26.6

Installation location : Floor

| ID       | GTIN          | Output (kW) | Sauna room size min - max m3 |
|----------|---------------|-------------|------------------------------|
| HL110400 | 6410082613175 | 11 kW       | 9.0-18.0                     |

## Related products

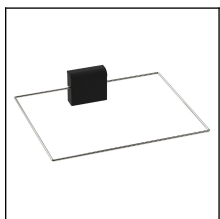

SFE-350400

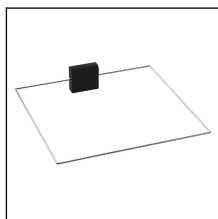

SFE-500500



HL1



HL3



HL3M

## Spare parts

| Product                    | ID      | Pcs |
|----------------------------|---------|-----|
| Heating element 3600W/230V | ZCU-836 | 3   |

## Technical details

| Technical data                     | Type / attribute   | HL110400 |
|------------------------------------|--|----------|
|                                    | Color  | Black    |
|                                    | Power output   | 11 kW    |
|                                    | Stone sizes  | 10-15 cm |
|                                    | Stone amount (kg)  | 70       |
| Dimensions                         | Product width (mm)   | 415      |
|                                    | Product height (mm)  | 810      |
|                                    | Product depth (mm)   | 485      |
|                                    | Net weight (kg)  | 26.6     |
|                                    | Gross weight   | 29       |
|                                    | Package width  | 500      |
|                                    | Package height   | 870      |
|                                    | Package depth  | 505      |
| Safety and installation dimensions | Safety distance front (non-combustible materials)  | 30       |
|                                    | Safety distance front (combustible materials)  | 30       |
|                                    | Safety distance side (non-combustible materials)   | 30       |
|                                    | Safety distance side (combustible materials)   | 30       |
|                                    | Safety distance behind (non-combustible materials)                                       | 30       |
|                                    | Safety distance (Ceiling) (depends on connections and therefore from output, star/delta) | 1100     |
|                                    | Room min. height(depends on connections and therefore from output, star/delta)           | 1900     |
|                                    | Installation opening height  | 1900     |
|                                    | Installation opening width   | 475      |
| Installation opening depth         | 400  |          |

Technical images

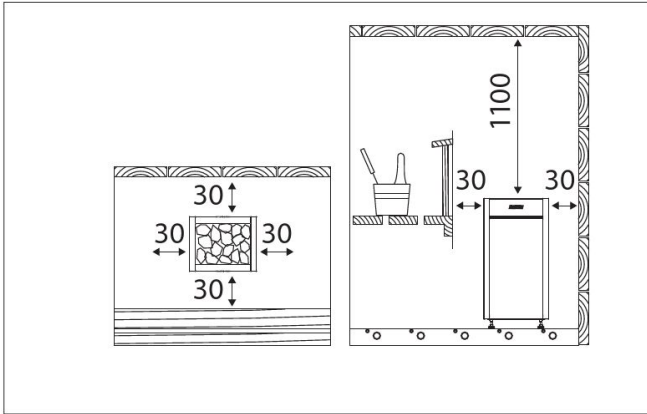

Minimum safety distances (all dimensions in millimeters)

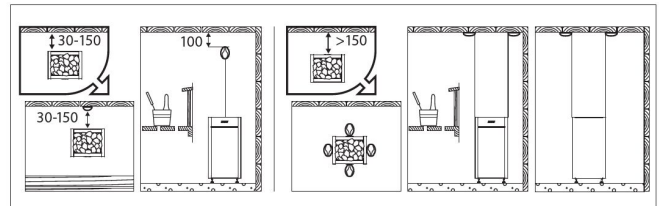

Installing the sensor (all dimensions in millimeters)

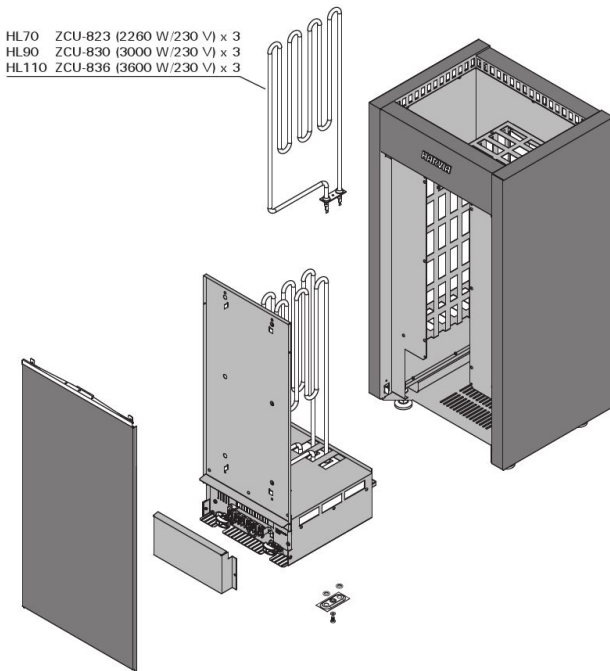

We recommend to use only the manufacturer's spare parts.

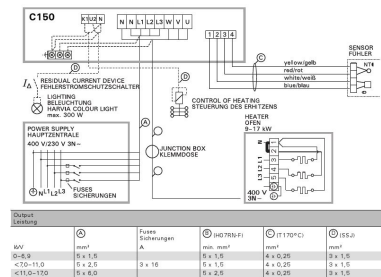

Electrical connections of control unit C150 and HL heater

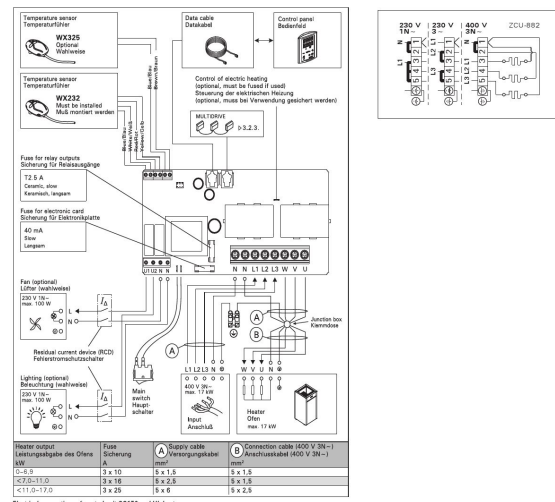

Electrical connections of control unit C275 and HL heater